

dESIGN
SUR-
FACES

C e R S A I E

/2023



INDICE PER SEZIONI

Section index/ Index sections/ Inhaltsverzeichnis abschnitte

<u>SERIE/SERIE / GAMME/SERIE</u>	<u>PAGINA/PAGE PAGE/SEITE</u>
effetto decoro / decor-look/ effet décor / dekoroptik	3
universal	4
effetto cemento / concrete-look effet ciment / zementoptik	8
continental	10
le resine	20
effetto pietra / stone-look effet pierre / steinoptik	34
dolomia stone	36
dolomia stone <u>vein cut</u>	36
saint-michel	58
effetto legno / wood-look effet bois / holzoptik	70
skyline	72
technical project 	
continental FP2	18
dolomia stone FP2	54
dolomia stone vein cut FP2	56
saint-michel FP2	68
skyline FP2	80

EFFETTO DECORO/
DECOR-LOOK/
EFFET DÉCOR/
DEKOROPTIK/

universal

4



a/ wall: LAPIS 61,0x122,2 cm R/24"x48" R
 CONTINENTAL WHITE 122,2x122,2 cm R/ 48"x48" R
 floor: CONTINENTAL WHITE 122,2x122,2 cm R/ 48"x48" R

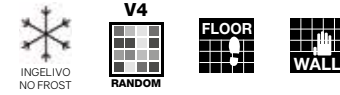

effetto decoro / decor-look / effet décor / dekoroptik

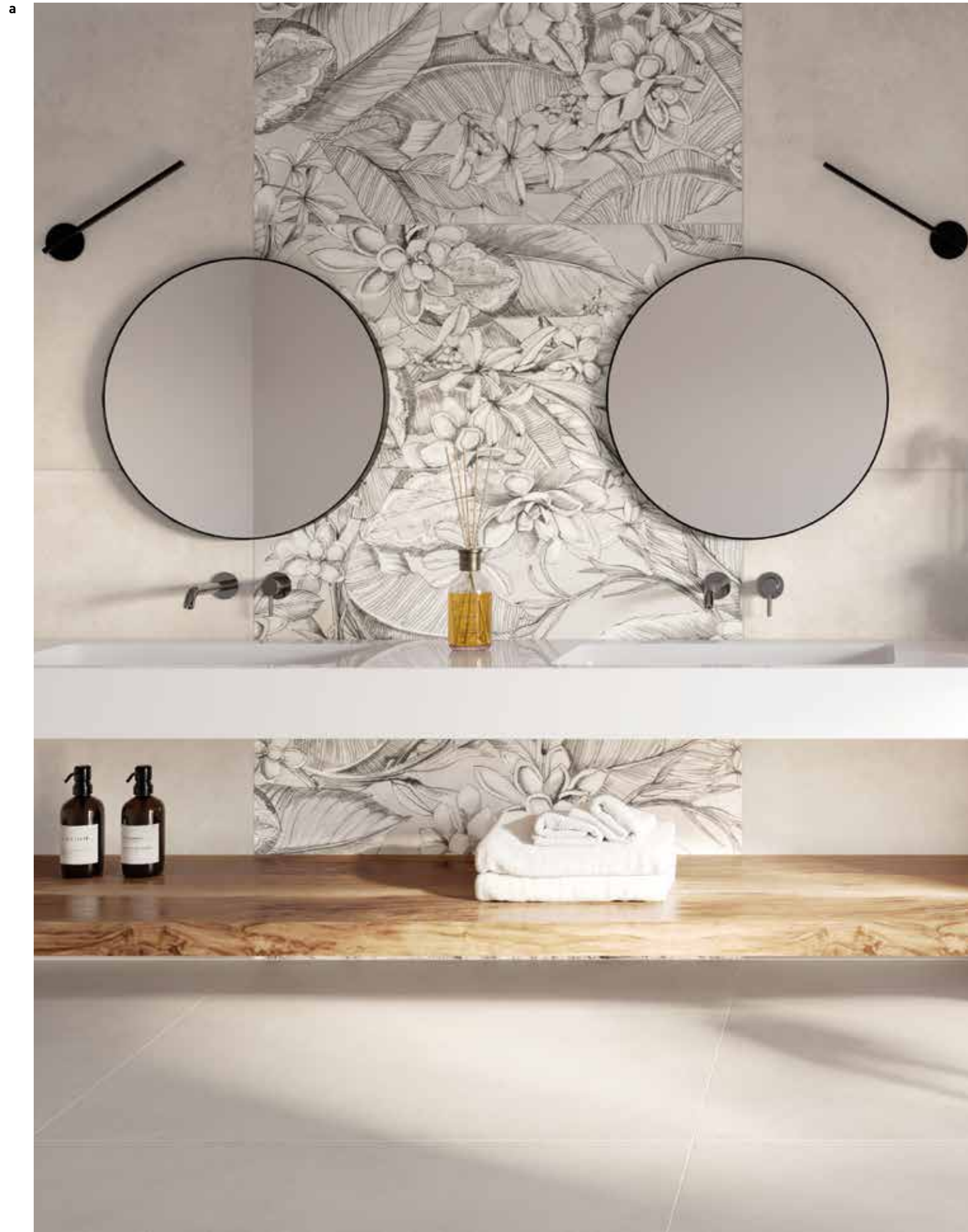

Colori / Colours / Couleurs / Farben



Formati / Sizes / Formats / Formate

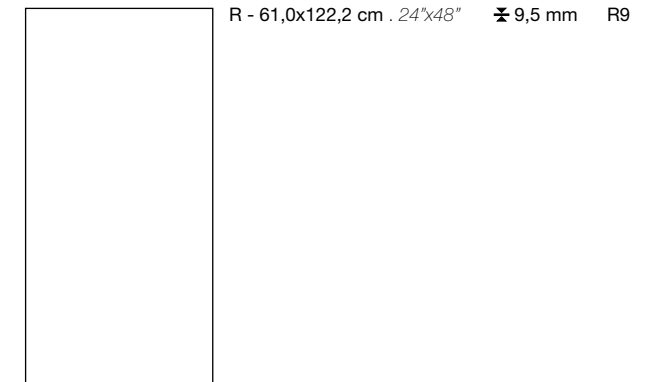

Decorati abbinabili con tutte le serie / Decorations can be combined with all series / Décorations combinable avec toutes les séries / Dekorationen können mit allen Serien kombiniert werden

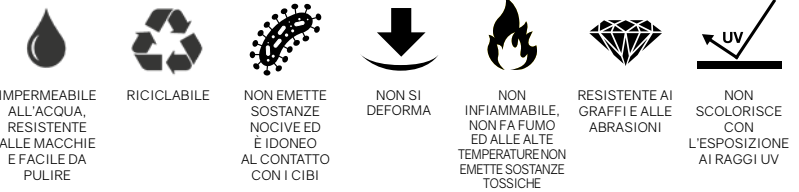

IMPERMEABILE ALL'ACQUA, RESISTENTE ALLE MACCHIE E FACILE DA PULIRE

RICICLABILE

NON EMETTE SOSTANZE NOCIVE ED È IDONEO AL CONTATTO CON I CIBI

NON SI DEFORMA

NON INFIAMMABILE, NON FA FUMO ED ALLE ALTE TEMPERATURE NON EMETTE SOSTANZE TOSSICHE

RESISTENTE AI GRAFFI E ALLE ABRASIONI

NON SCOLORISCE CON L'ESPOSIZIONE AI RAGGI UV

Formati / Sizes / Formats / Formate	R - 61,0x122,2 cm 24"x48" ± 9,5 mm R9
LAPIS	●
NINFA	●

R: Rettificato / Rectified

UNIVERSAL LAPIS

b/ wall: LAPIS 61,0x122,2 cm R/24"x48" R
 CONTINENTAL WHITE 122,2x122,2 cm R/ 48"x48" R
 TEAK CONTINENTAL WHITE 30,4x122,2 cm R/ 12"x48" R
 floor: CONTINENTAL WHITE 122,2x122,2 cm R/ 48"x48" R
 TEAK CONTINENTAL WHITE 30,4x122,2 cm R/ 12"x48" R

Per la disponibilità articolo: www.tuscaniagres.it digitando il codice web segnalato a lato dei formati.
 For the item's availability: www.tuscaniagres.it type the web code reported next to the sizes.
 Pour vérifier la disponibilité de l'article: www.tuscaniagres.it en saisissant le code web indiqué à coté des formats.
 Für die Artikelverfügbarkeit: www.tuscaniagres.it web code eingeben, an der Seite von Formaten angedeutet.



LAPIS

O1V9 61,0x122,2 cm 24"x48"-R B181

4 soggetti diversi, miscelazione casuale. / 4 assorted motifs, random mix. / 4 sujets différents, melange aleatoire. / 4 verschiedene Motive, Zufallsmischung.



UNIVERSAL NINFA

c/ wall: NINFA 61,0x122,2 cm R/24"x48" R
 SKYLINE TEAK NATIVE 30,4x122,2 cm R/12"x48" R
 floor: SKYLINE NATIVE 26,0x160,0 cm R/10"x63" R

Per la disponibilità articolo: www.tuscaniagres.it digitando il codice web segnalato a lato dei formati.
 For the item's availability: www.tuscaniagres.it type the web code reported next to the sizes.
 Pour vérifier la disponibilité de l'article: www.tuscaniagres.it en saisissant le code web indiqué à coté des formats.
 Für die Artikelverfügbarkeit: www.tuscaniagres.it web code eingeben, an der Seite von Formaten angedeutet.



NINFA

O2V0 61,0x122,2 cm 24"x48"-R B181

1 soggetto. / 1 motif. / 1 sujet. / 1 Motive.

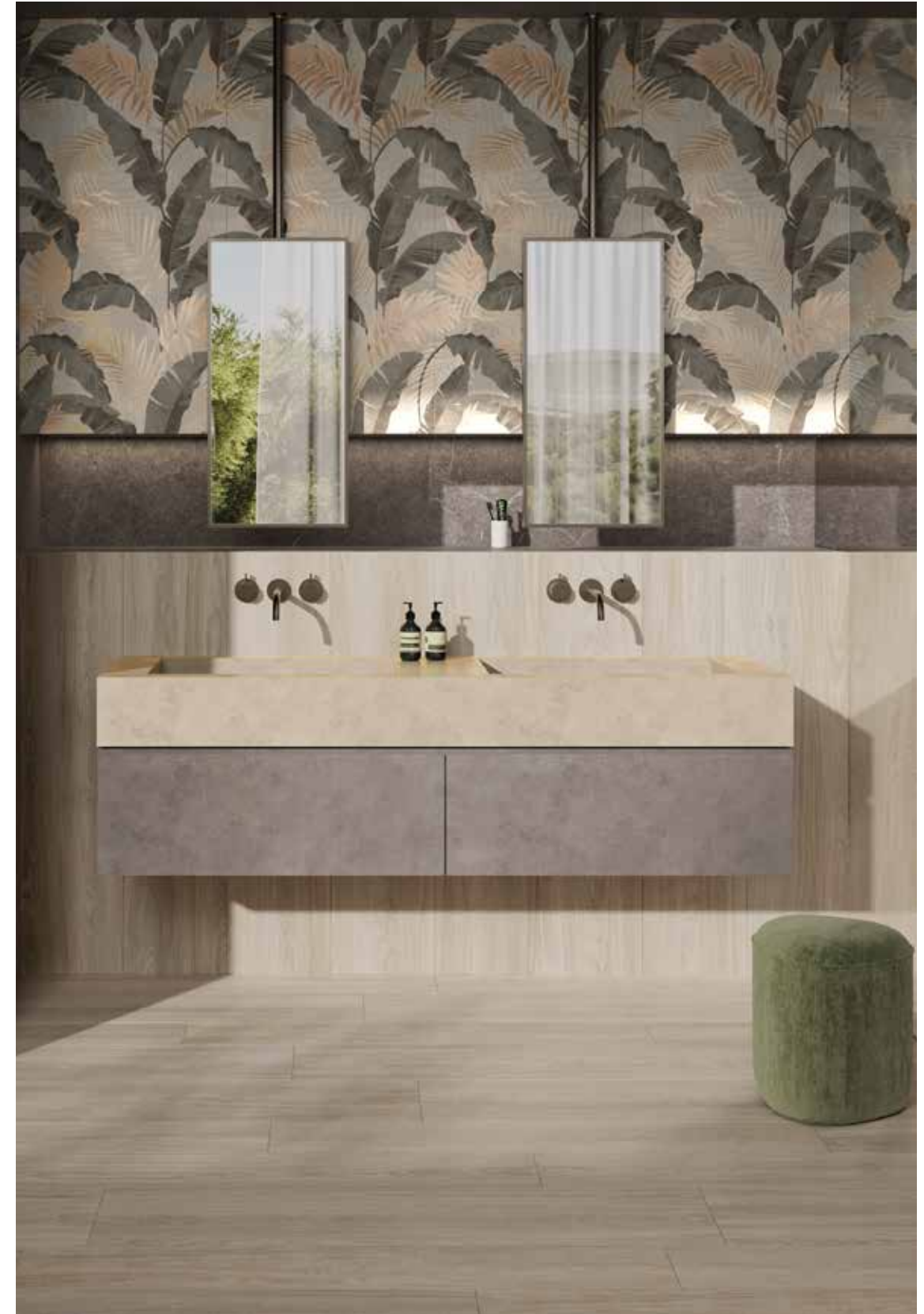

EFFETTO CEMENTO/
CONCRETE-LOOK/
EFFET CIMENT/
ZEMENTOPTIK/

continental	10
le resine	20



CONTINENTAL



b/ floor : TAUPE 122,2x122,2 cm R/ 48"x48" R
 wall : 61,0x122,2 cm R/ 24"x48" R
 furniture: TEAK TAUPE 30,4x122,2 cm R/ 12"x48" R

c/ floor e wall: WHITE 122,2x122,2 cm R/ 48"x48" R
 TEAK WHITE 30,4x122,2 cm R/ 12"x48" R
 wall: UNIVERAL LAPIS 61,0x122,2 cm R/24"x48" R

d/ SMOKE 61,0x122,2 cm R/ 24"x48" R



dESIGN SUR- FACES

WHITE

SMOKE

SAND

TAUPE

CONTINENTAL

WHITE

O0V4	122,2x122,2 cm 48"x48" - R	B230
O1V1	61,0x122,2 cm 24"x48" - R	B180
O0X8	61,0x122,2 cm 24"x48" OUTDOOR - R	B182
O1X2	30,4x122,2 cm 12"x48" TEAK - R	A121
O1X5	80x80 cm 32"x32" - R	A200
O1X9	61,0x61,0 cm 24"x24" - R	B192
O2X3	30,4x61,0 cm 12"x24" - R	C110
O9W1	61,0x122 cm 24"x48" - FP-E R	A184
O2X7	61,0x61,0 cm 24"x24" - FP-E R	B198

SMOKE

O0V7	122,2x122,2 cm 48"x48" - R	B230
O1V4	61,0x122,2 cm 24"x48" - R	B180
O1X0	61,0x122,2 cm 24"x48" OUTDOOR - R	B182
O8W5	30,4x122,2 cm 12"x48" TEAK - R	A121
O1X6	80x80 cm 32"x32" - R	A200
O2X0	61,0x61,0 cm 24"x24" - R	B192
O2X4	30,4x61,0 cm 12"x24" - R	C110
O6W8	61,0x122 cm 24"x48" - FP-E R	A184
O2X8	61,0x61,0 cm 24"x24" - FP-E R	B198

SAND

O0V5	122,2x122,2 cm 48"x48" - R	B230
O1V2	61,0x122,2 cm 24"x48" - R	B180
O0X9	61,0x122,2 cm 24"x48" OUTDOOR - R	B182
O1X3	30,4x122,2 cm 12"x48" TEAK - R	A121
O1X7	80x80 cm 32"x32" - R	A200
O2X1	61,0x61,0 cm 24"x24" - R	B192
O2X5	30,4x61,0 cm 12"x24" - R	C110
O8W9	61,0x122 cm 24"x48" - FP-E R	A184
O2X9	61,0x61,0 cm 24"x24" - FP-E R	B198

TAUPE

O0V6	122,2x122,2 cm 48"x48" - R	B230
O1V3	61,0x122,2 cm 24"x48" - R	B180
O1X1	61,0x122,2 cm 24"x48" OUTDOOR - R	B182
O1X4	30,4x122,2 cm 12"x48" TEAK - R	A121
O1X8	80x80 cm 32"x32" - R	A200
O2X2	61,0x61,0 cm 24"x24" - R	B192
O2X6	30,4x61,0 cm 12"x24" - R	C110
O9W0	61,0x122 cm 24"x48" - FP-E R	A184
O3X0	61,0x61,0 cm 24"x24" - FP-E R	B198

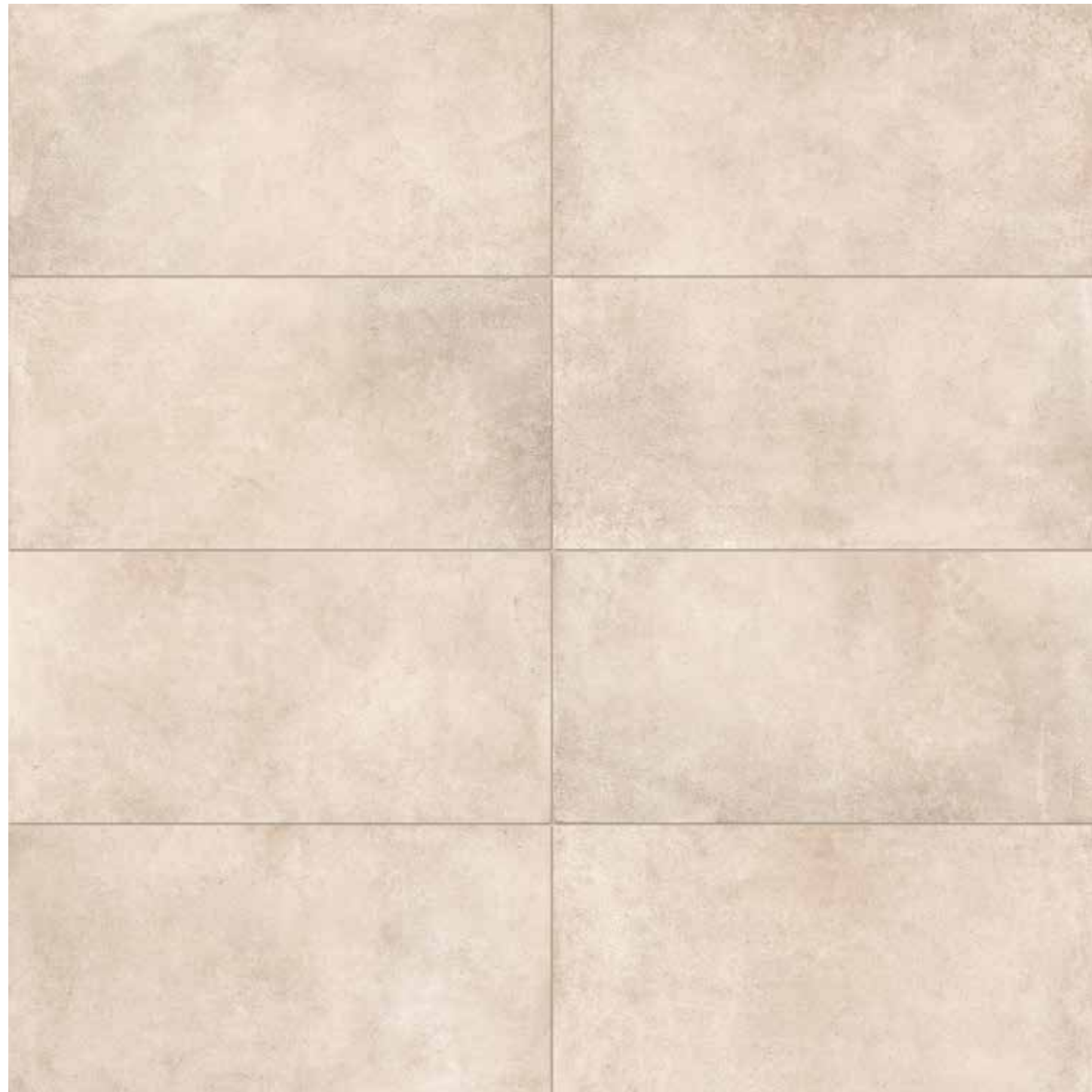

SAND

Sviluppo grafico / Design development / Développement graphique / Grafische Entwicklung 61,0x122,2 cm 24"x48" R
(8 grafiche diverse / 8 different design / 8 graphiques différents / 8 verschiedene Grafische)

Decori / Decors / Décors / Dekors

mosaico monocoloro 81 tessere 3x3 - 30x30 cm 12"x12"  **P73**



WHITE

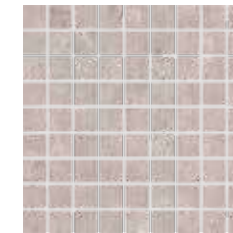

SMOKE



SAND



TAUPE

teak - 9 bacchette

TEAK WHITE

O1X2 30,4x122,2 cm 12"x48" TEAK - R **A121**



TEAK SMOKE

O8W5 30,4x122,2 cm 12"x48" TEAK - R **A121**



TEAK SAND









O1X3 30,4x122,2 cm 12"x48" TEAK - R **A121**



TEAK TAUPE

O1X4 30,4x122,2 cm 12"x48" TEAK - R **A121**



Pezzi Speciali / Special Pieces / Pièces Spéciales / Formteile							
	battiscopa 6,5x122,2 cm 2 1/2"x48" R  P05	elemento "L" monolitico outdoor 15x30x4 cm 6"x12"x1 3/4"  P50	step 30,4x61,0 cm 12"x24" R P90	gradino costa retta 34x122,2x4 cm 13"x48"x1 3/4" R P32	gradino costa retta 34x61,0x4 cm 13"x24"x1 3/4" R P31	vista frontale angolare costa retta dx/sx 34x122,2x4 cm 13"x48"x1 3/4" R P41	vista dal retro angolare costa retta dx/sx 34x34x4 cm 13"x13"x1 3/4" R P40
WHITE	●	●	●	●	●	●	●
SMOKE	●	●	●	●	●	●	●
SAND	●	●	●	●	●	●	●
TAUPE	●	●	●	●	●	●	●

Note / Notes / Notes / Anmerkungen

I battiscopa e gli elementi "L" vengono venduti a pz. e a scatola completa. Tutti gli altri pezzi speciali vengono venduti al pezzo. I gradini vengono prodotti solo su ordinazione (tempo minimo di consegna 20 gg lavorativi).
All skirting and monolithic L elements, priced per piece, are sold in full box. All other special trims are sold by piece. Steps are produced only on request (minimum delivery terms of 20 days).
Les plinthes et élément "L" sont vendues la pièce et par boîte complète. Les autres pièces spéciales sont vendus la pièce. Le plat de marche sont produit sur demande (délai minimum de 20 jours).
Die Sockelleisten und Stufen werden pro Stk. und Vollen Kartons verkauft. Stufen und Stufenecken werden nur auf Bestellung produziert (Lieferzeiten mindesten 20 arbeitstagen ab Auftragserteilung).

CONTINENTAL

effetto cemento / concrete-look / effet ciment / zementoptik

Colori / Colours / Couleurs / Farben



R: Rettificato/ Rectified

Formati / Sizes / Formats / Formate	R - 61,0x122 cm 24"x48" ± 20 mm FP2 R11	R - 61,0x61 cm 24"x24" ± 20 mm FP2 R11
WHITE	●	●
SMOKE	●	●
SAND	●	●
TAUPE	●	●



Formati / Sizes / Formats / Formate

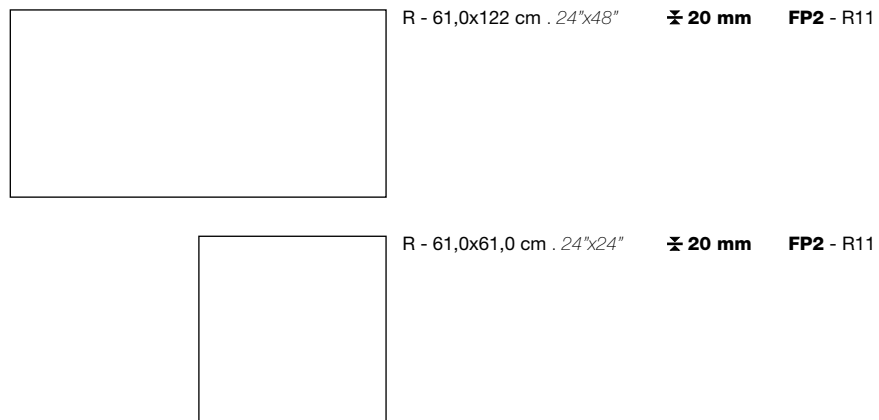

e/outdoor: WHITE FP2
61,0x122 cm R/24"x48"R
indoor: WHITE
122,2x122,2 cm R/48"x48" R

CONTINENTAL

Per la disponibilità articolo: www.tuscaniagres.it digitando il codice web segnalato a lato dei formati.
For the item's availability: www.tuscaniagres.it type the web code reported next to the sizes.
Pour vérifier la disponibilité de l'article: www.tuscaniagres.it en saisissant le code web indiqué à coté des formats.
Für die Artikelverfügbarkeit: www.tuscaniagres.it web code eingeben, an der Seite von Formaten angeedeutet.



FP2 Pezzi Speciali / Special Pieces / Pièces Spéciales / Formteile	elemento "L" 61x122x5 cm 24"x48"x2" R		elemento "L" 30x61x5 cm 12"x24"x2" R		angolare elemento "L" SX/DX 61x61x5 cm 24"x24"x2" R		angolare elemento "L" SX/DX 30x30x5 cm 12"x12"x2" R		griglia 20x61 cm 8"x24" R abbinata al 61x122 cm combined with the 24"x48"		griglia 20x61 cm 8"x24" R abbinata al 61x61 cm combined with the 24"x24"		angolo SX griglia angolo 20x61 cm 8"x24" R abbinata al 61x122 cm combined with the 24"x48"		angolo DX griglia angolo 20x61 cm 8"x24" R abbinata al 61x61 cm combined with the 24"x24"	
	P102A	P100	P105A	P103	P106D	P106A	P109B COPPIA	P107 COPPIA								
WHITE	●	●	●	●	●	●	●	●	●	●	●	●	●	●	●	
SMOKE	●	●	●	●	●	●	●	●	●	●	●	●	●	●	●	
SAND	●	●	●	●	●	●	●	●	●	●	●	●	●	●	●	
TAUPE	●	●	●	●	●	●	●	●	●	●	●	●	●	●	●	

	round lineare 30x122 cm 12"x48" R		round lineare 30x61 cm 12"x24" R		angolo SX round angolare 30x122 cm 12"x48" R		angolo DX round angolare 30x61 cm 12"x24" R		angolo SX angolo bordo toro 30x122 cm 12"x48" R		angolo DX angolo bordo toro 30x61 cm 12"x24" R	
	P112A	P110	P113C COPPIA	P113A COPPIA	P117	P114						
WHITE	●	●	●	●	●	●						
SMOKE	●	●	●	●	●	●						
SAND	●	●	●	●	●	●						
TAUPE	●	●	●	●	●	●						

Note - Notes - Notes - Anmerkungen
I pezzi speciali FP2 vengono venduti al pezzo e solo su ordinazione (tempo minimo di consegna 20 gg lavorativi dall'ordine).
The special pieces FP2 are sold by piece and only on request (minimum delivery time 20 working days from date of order).
Les pièces spéciales FP2 sont vendus à la pièce et uniquement sur commande (délai minimum de livraison 20 jours ouvrés à partir de la commande).
Spezial Teile FP2 sind pro Stück verkauft und nur auf Bestellungen produziert. (Lieferzeiten mindesten 20 arbeitstage ab Auftragbestätigung)

a/ floor: RESINA TORTORA 122,2x122,2 cm RS/ 48"x48" RS
 TEAK RESINA TORTORA 30,4x122,2 cm RS/ 12"x48" RS
 wall: RESINA DECORO 61,0x122,2 cm RS/ 24"x48" RS





effetto cemento / concrete-look / effet ciment / zementoptik



Colori / Colours / Couleurs / Farben

-  RESINA BIANCO
-  RESINA CENERE
-  RESINA GRIGIO
-  RESINA BEIGE
-  RESINA TORTORA
-  RESINA DECORO

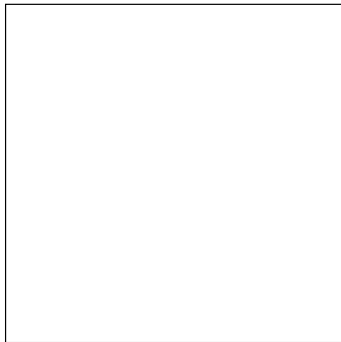
Formati / Sizes / Formats / Formate

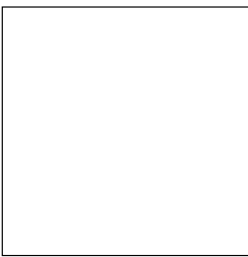
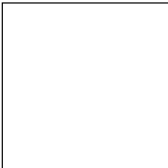
	RS - 122,2x122,2 cm . 48"x48"	± 9,5 mm	R9
	RS - 61,0x122,2 cm . 24"x48"	± 9,5 mm	R9
	RS - 61,0x122,2 cm . 24"x48"	± 9,5 mm	OUTDOOR - R11
	RS - 61,0x122,2 cm . 24"x48" DECORO	± 9,5 mm	R9
	RS - 30,4x122,2 cm . 12"x48"	± 9,5 mm	TEAK - R9
	RS - 90x90 cm . 36"x36"	± 9,5 mm	R9
	RS - 61,0x61,0 cm . 24"x24"	± 9,0 mm	R9
	NS - 61,5x61,5 cm . 24"x24"	± 9,0 mm	OUTDOOR - R11

RS: Rettificato-Strutturato / Rectified-Textured

NS: Naturale-Strutturato / Natural-Textured

Formati / Sizes / Formats / Formate	RS-122,2x122,2 cm 48"x48" ± 9,5 mm	RS - 90x90 cm 36"x36" ± 9,5 mm	RS - 61,0x122,2 cm 24"x48" ± 9,5 mm	RS - 61,0x122,2 cm 24"x48" ± 9,5 mm OUTDOOR R11	RS - 30,4x122,2 cm 12"x48" ± 9,5 mm TEAK R9	RS - 61,0x61,0 cm 24"x24" ± 9,0 mm	NS - 61,5x61,5 cm 24"x24" ± 9,0 mm OUTDOOR R11
RESINA BIANCO	●	●	●		●	●	
RESINA CENERE	●	●	●		●	●	
RESINA GRIGIO	●	●	●	●	●	●	●
RESINA BEIGE	●	●	●	●	●	●	●
RESINA TORTORA	●	●	●	●	●	●	●
RESINA DECORO			●				



b



c



d

b-c/ floor: RESINA TORTORA 61,0x122,2 cm RS/ 24"x48" RS
 wall: RESINA TORTORA, BEIGE 61,0x122,2 cm RS/ 24"x48" RS
 TEAK RESINA TORTORA, BEIGE 30,4x122,2 cm RS/ 12"x48" RS

d/ floor: RESINA TORTORA 122,2x122,2 cmRS/ 48"x48" RS
 TEAK RESINA TORTORA 30,4x122,2 cm RS/ 12"x48" RS
 wall: RESINA DECORO 61,0x122,2 cm RS/ 24"x48" RS

e



e/ floor: RESINA CENERE 90x90 cm RS/ 36"x36" RS
 wall: TEAK RESINA CENERE 30,4x122,2 cm RS/ 12"x48" RS

f/ RESINA CENERE 90x90 cm RS/ 36"x36" RS

g/ wall: TEAK RESINA CENERE 30,4x122,2 cm RS/ 12"x48" RS
 floor: RESINA CENERE 90x90 cm RS/ 36"x36" RS



f



g

h/ wall: RESINA BIANCO 61,0x122,2 cm RS/ 24"x48" RS
 floor: SLASH DARK GREY 61,0x122,2 cm RS/24"x48" RS
 furniture: SLASH DARK GREY mosaico asimmetrico 18 pz - 30x30 cm 12"x12"

i/ floor: RESINA GRIGIO 122,2x122,2 cm RS/ 48"x48" RS
 wall: TEAK FIRENZE NATURALE 30,4x122,2 cm RS/ 12"x48" RS

V/ RESINA GRIGIO 122,2x122,2 cm RS/ 48"x48" RS



h

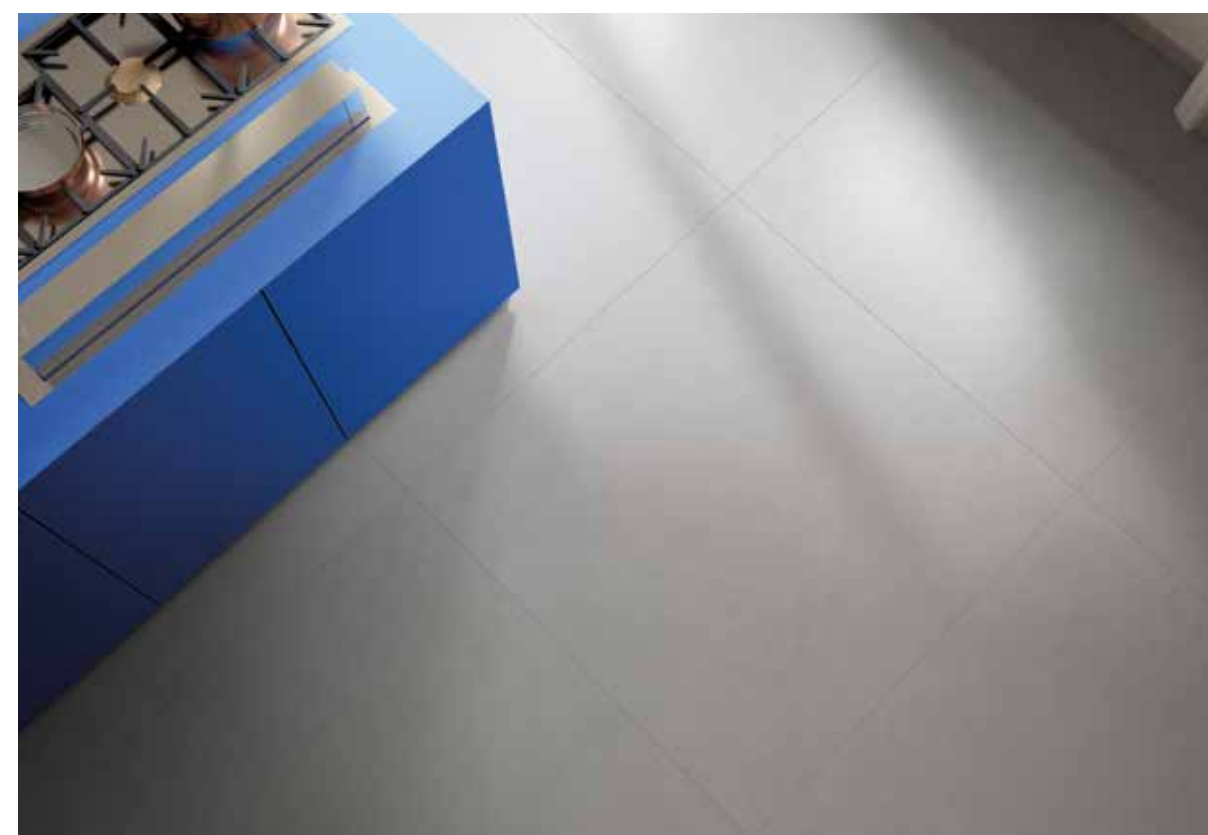

i



m

m-n/ floor: RESINA BIANCO 61,0x122,2 cm RS/ 24"x48" RS
wall: RESINA DECORO 61,0x122,2 cm RS/ 24"x48" RS



n

RESINA BIANCO

RESINA CENERE

RESINA GRIGIO

RESINA DECORO

dESIGN
SUR-
FACES

RESINA BEIGE

RESINA TORTORA

RESINA DECORO

O2M5 61,0x122,2 cm 24"x48" DECORO - RS B181



RESINA BIANCO

O0L8 122,2x122,2 cm 48"x48" - RS B230
 O3L5 90x90 cm 36"x36" - RS B220
 O1L3 61,0x122,2 cm 24"x48" - RS B180
 O0N6 30,4x122,2 cm 12"x48" TEAK - RS A121
 O6M2 61,0x61,0 cm 24"x24" - RS B192

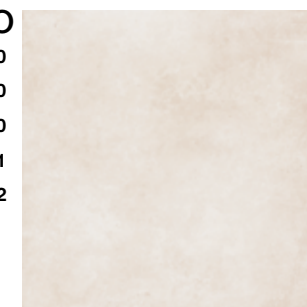

RESINA CENERE

O1L1 122,2x122,2 cm 48"x48" - RS B230
 O3L6 90x90 cm 36"x36" - RS B220
 O1L6 61,0x122,2 cm 24"x48" - RS B180
 O1N0 30,4x122,2 cm 12"x48" TEAK - RS A121
 O6M3 61,0x61,0 cm 24"x24" - RS B192



RESINA GRIGIO

O1L2 122,2x122,2 cm 48"x48" - RS B230
 O3L7 90x90 cm 36"x36" - RS B220
 O1L7 61,0x122,2 cm 24"x48" - RS B180
 O7M5 61,0x122,2 cm 24"x48" - OUTDOOR RS B182
 O0N7 30,4x122,2 cm 12"x48" TEAK - RS A121
 O6M4 61,0x61,0 cm 24"x24" - RS B192
 O7N0 61,5x61,5 cm 24"x24" - OUTDOOR NS A191

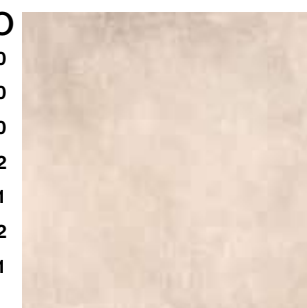

RESINA BEIGE

O0L9 122,2x122,2 cm 48"x48" - RS B230
 O3L4 90x90 cm 36"x36" - RS B220
 O1L4 61,0x122,2 cm 24"x48" - RS B180
 O7M4 61,0x122,2 cm 24"x48" - OUTDOOR RS B182
 O0N8 30,4x122,2 cm 12"x48" TEAK - RS A121
 O6M5 61,0x61,0 cm 24"x24" - RS B192
 O7M0 61,5x61,5 cm 24"x24" - OUTDOOR NS A191

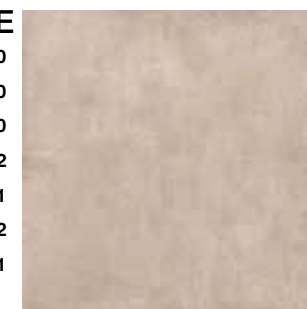

RESINA TORTORA

O1L0 122,2x122,2 cm 48"x48" - RS B230
 O3L8 90x90 cm 36"x36" - RS B220
 O1L5 61,0x122,2 cm 24"x48" - RS B180
 O7M6 61,0x122,2 cm 24"x48" - OUTDOOR RS B182
 O0N9 30,4x122,2 cm 12"x48" TEAK - RS A121
 O6M6 61,0x61,0 cm 24"x24" - RS B192
 O7M2 61,5x61,5 cm 24"x24" - OUTDOOR NS A191

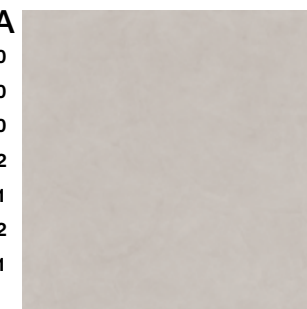

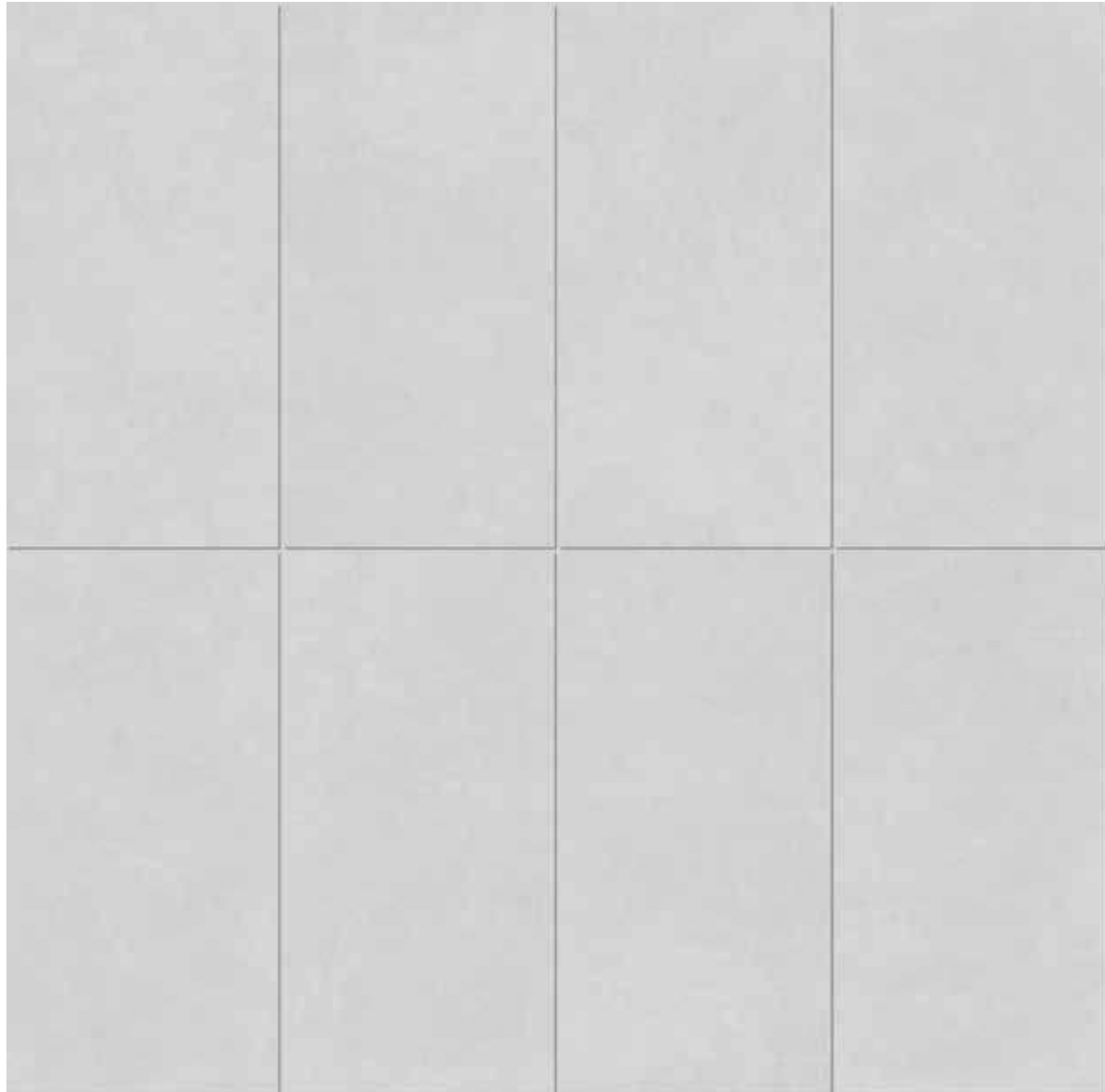

RESINA CENERE

Sviluppo grafico / Design development / Développement graphique / Grafische Entwicklung 61,0x122,2 cm 24"x48" RS
(8 grafiche diverse / 8 different design / 8 graphiques différents / 8 verschiedene Grafische)



RESINA DECORO

Sviluppo grafico / Design development / Développement graphique / Grafische Entwicklung 61,0x122,2 cm 24"x48" RS
(4 grafiche diverse / 4 different design / 4 graphiques différents / 4 verschiedene Grafische)

Decor / Decors / Décors / Dekors

mosaico monocolore 81 tessere 3x3 - 30x30 cm 12"x12"  P73

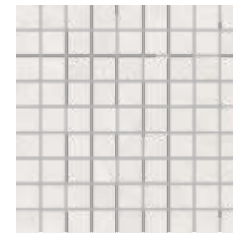

RESINA BIANCO

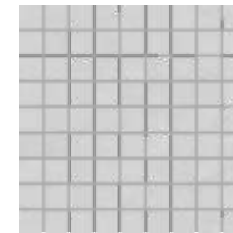

RESINA CENERE

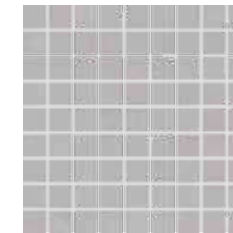

RESINA GRIGIO

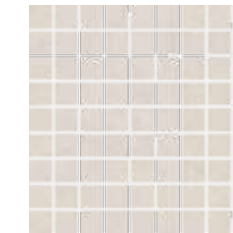

RESINA BEIGE



RESINA TORTORA

teak - 9 bacchette

TEAK RESINA BIANCO

O0N6 30,4x122,2 cm 12"x48" TEAK - RS A121



TEAK RESINA CENERE

O1N0 30,4x122,2 cm 12"x48" TEAK - RS A121



TEAK RESINA GRIGIO

O0N7 30,4x122,2 cm 12"x48" TEAK - RS A121



TEAK RESINA BEIGE





O0N8 30,4x122,2 cm 12"x48" TEAK - RS A121



TEAK RESINA TORTORA

O0N9 30,4x122,2 cm 12"x48" TEAK - RS A121

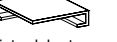

Pezzi Speciali / Special Pieces / Pièces Spéciales / Formteile						
	battiscopa 6,5x122,2 cm 2 1/2"x48" RS P05	elemento "L" monolitico outdoor 15x30x4 cm 6"x12"x1 3/4" RS P50	gradino costa retta 34x122,2x4 cm 13"x48"x1 3/4" RS P32	gradino costa retta 34x61,0x4 cm 13"x24"x1 3/4" RS P31	vista frontale angolare costa retta dx/sx 34x122,2x4 cm 13"x48"x1 3/4" RS P41	vista dal retro angolare costa retta dx/sx 34x34x4 cm 13"x13"x1 3/4" RS P40
RESINA BIANCO	•		•	•	•	•
RESINA CENERE	•		•	•	•	•
RESINA GRIGIO	•	•	•	•	•	•
RESINA BEIGE	•	•	•	•	•	•
RESINA TORTORA	•	•	•	•	•	•

Note / Notes / Notes / Anmerkungen
I battiscopa e gli elementi "L" vengono venduti a pz. e a scatola completa. Tutti gli altri pezzi speciali vengono venduti al pezzo. I gradini vengono prodotti solo su ordinazione (tempo minimo di consegna 20 gg lavorativi).
All skirting and monolithic L elements, priced per piece, are sold in full box. All other special trims are sold by piece. Steps are produced only on request (minimum delivery terms of 20 days).
Les plinthes et élément "L" sont vendues la pièce et par boîte complète. Les autres pièces spéciales sont vendus la pièce. Le plat de marche sont produit sur demande (délai minimum de 20 jours).
Die Sockelleisten und Stufen werden pro Stk. und Vollen Kartons verkauft. Stufen und Stufenecken werden nur auf Bestellung produziert (Lieferzeiten mindesten 20 arbeitstagen ab Auftragserteilung).

EFFETTO PIETRA/
STONE-LOOK/
EFFET PIERRE/
STEINOPTIK/

dolomia stone	36
dolomia stone <u>vein cut</u>	36
saint-michel	38



DOLOMIA STONE

a/ floor: GREY 122,2x122,2 cm RS/48"x48" RS
 furniture: GREY mosaico monocolore 30x30 cm/12"x12"
 wall: FIRENZE ROVERE 26,0x160,0 cm RS/10"x63" RS



DOLOMIA STONE 37

effetto pietra / stone-look / effet pierre / steinoptik

Colori / Colours / Couleurs / Farben



Formati / Sizes / Formats / Formate

	RS - 122,2x122,2 cm . 48"x48" \pm 9,5 mm R10 LCR - 122,2x122,2 cm . 48"x48" \pm 9,5 mm
	RS - 61,0x122,2 cm . 24"x48" \pm 9,5 mm R10 RS - 61,0x122,2 cm . 24"x48" \pm 9,5 mm OUTDOOR - R11 LCR - 61,0x122,2 cm . 24"x48" \pm 9,5 mm RS - 61,0x122 cm . 24"x48" \pm 20 mm FP2 - R11
	RS - 90x90 cm . 36"x36" \pm 9,5 mm R10 RS - 90x90 cm . 36"x36" \pm 20 mm FP2 - R11
	RS - 60x90 cm . 24"x36" \pm 20 mm FP2 - R11
	RS - 61,0x61,0 cm . 24"x24" \pm 9,0 mm R10 LCR - 61,0x61,0 cm . 24"x24" \pm 9,0 mm RS - 61,0x61,0 cm . 24"x24" \pm 20 mm FP2 - R11
	RS - 30,4x61,0 cm . 12"x24" \pm 9,0 mm R10

Colori / Colours / Couleurs / Farben **VEIN CUT**



Formati / Sizes / Formats / Formate **VEIN CUT**

	RS - 61,0x122,2 cm . 24"x48" \pm 9,5 mm VEIN CUT R10 RS - 61,0x122,2 cm . 24"x48" \pm 9,5 mm VEIN CUT OUTDOOR - R11 LCR - 61,0x122,2 cm . 24"x48" \pm 9,5 mm VEIN CUT RS - 61,0x122 cm . 24"x48" \pm 20 mm VEIN CUT FP2 - R11
	RS - 30,4x61,0 cm . 12"x24" \pm 9,0 mm VEIN CUT R10

RS: Rettificato-Strutturato / Rectified-Textured

LCR: Lappato in cresta e rettificato / Semi-polished and rectified

Formati / Sizes / Formats / Formate	RS 122,2x122,2 cm 48"x48" \pm 9,5 mm R10	LCR 122,2x122,2 cm 48"x48" \pm 9,5 mm	RS 90x90 cm 36"x36" \pm 9,5 mm R10	RS 90x90 cm 36"x36" \pm 20 mm FP2 R11	RS 61,0x122,2 cm 24"x48" \pm 9,5 mm R10	RS 61,0x122,2 cm 24"x48" \pm 9,5 mm OUTDOOR R11	LCR 61,0x122,2 cm 24"x48" \pm 9,5 mm	RS 61,0x122 cm 24"x48" \pm 20 mm FP2 R11	RS 61,0x61,0 cm 24"x24" \pm 9,0 mm R10	LCR 61,0x61,0 cm 24"x24" \pm 9,0 mm	RS 61,0x61,0 cm 24"x24" \pm 20 mm FP2 R11	RS 60x90 cm 24"x36" \pm 20 mm FP2 R11	RS 30,4x61,0 cm 12"x24" \pm 9,0 mm R10
WHITE	●	●	●	●	●	●	●	●	●	●	●	●	●
GREY	●	●	●	●	●	●	●	●	●	●	●	●	●
ALMOND	●	●	●	●	●	●	●	●	●	●	●	●	●
WHITE VEIN CUT					●	●	●	●					●
GREY VEIN CUT					●	●	●	●					●
ALMOND VEIN CUT					●	●	●	●					●

DOLOMIA Stone



b

b/ GREY 61,0x122,2 cm LCR/24"x48" LCR
c/ floor: WHITE 122,2x122,2 cm RS/48"x48" RS
 furniture: GREY 61,0x122,2 cm RS/24"x48" RS



c



DOLOMIA STONE ⁴¹

d/ WHITE, ALMOND 61,0x122,2 cm LCR/24"x48" LCR

e/ ALMOND 61,0x122,2 cm RS/24"x48" RS
90x90 cm RS/36"x36" RS





f/ GREY VEIN CUT 61,0x122,2 cm RS/24"x48" RS

g/ GREY VEIN CUT 61,0x122,2 cm LCR/24"x48" LCR





h



i



l

h/ floor: ALMOND VEIN CUT 61,0x122,2 cm LCR/24"x48" LCR
wall: WHITE VEIN CUT 61,0x122,2 cm LCR/24"x48" LCR

i/ ALMOND VEIN CUT 61,0x122,2 cm RS/24"x48" RS

l/ WHITE VEIN CUT 61,0x122,2 cm RS/24"x48" RS

WHITE

GREY

DESIGN
SUR-
FACES

ALMOND

DOLOMIA STONE 47

WHITE

O1G4	122,2x122,2 cm 48"x48" - RS	B230
O3M5	122,2x122,2 cm 48"x48" - LCR	B231
O1G0	90x90 cm 36"x36" - RS	B220
O8F4	61,0x122,2 cm 24"x48" - RS	B180
O8F8	61,0x122,2 cm 24"x48" - OUTDOOR RS	B182
O4M0	61,0x122,2 cm 24"x48" - LCR	B183
O8F0	61,0x61,0 cm 24"x24" - RS	B192
O8M3	61,0x61,0 cm 24"x24" - LCR	C199
O7F6	30,4x61,0 cm 12"x24" - RS	C110

O7M7	90x90 cm 36"x36" - FP-E RS	B225
O2G4	61,0x122 cm 24"x48" - FP-E RS	A184
O2G0	61,0x61,0 cm 24"x24" - FP-E RS	B198
O5J6	60x90 cm 24"x36" - FP-E RS	A179

GREY

O1G5	122,2x122,2 cm 48"x48" - RS	B230
O3M4	122,2x122,2 cm 48"x48" - LCR	B231
O1G1	90x90 cm 36"x36" - RS	B220
O8F5	61,0x122,2 cm 24"x48" - RS	B180
O8F9	61,0x122,2 cm 24"x48" - OUTDOOR RS	B182
O4M2	61,0x122,2 cm 24"x48" - LCR	B183
O8F1	61,0x61,0 cm 24"x24" - RS	B192
O8M4	61,0x61,0 cm 24"x24" - LCR	C199
O7F7	30,4x61,0 cm 12"x24" - RS	C110

O7M8	90x90 cm 36"x36" - FP-E RS	B225
O2G5	61,0x122 cm 24"x48" - FP-E RS	A184
O2G1	61,0x61,0 cm 24"x24" - FP-E RS	B198
O5J7	60x90 cm 24"x36" - FP-E RS	A179

ALMOND

O1G7	122,2x122,2 cm 48"x48" - RS	B230
O3M3	122,2x122,2 cm 48"x48" - LCR	B231
O1G3	90x90 cm 36"x36" - RS	B220
O8F7	61,0x122,2 cm 24"x48" - RS	B180
O9F1	61,0x122,2 cm 24"x48" - OUTDOOR RS	B182
O3M1	61,0x122,2 cm 24"x48" - LCR	B183
O8F3	61,0x61,0 cm 24"x24" - RS	B192
O8M5	61,0x61,0 cm 24"x24" - LCR	C199
O7F9	30,4x61,0 cm 12"x24" - RS	C110

O7M9	90x90 cm 36"x36" - FP-E RS	B225
O2G7	61,0x122 cm 24"x48" - FP-E RS	A184
O2G3	61,0x61,0 cm 24"x24" - FP-E RS	B198
O5J5	60x90 cm 24"x36" - FP-E RS	A179

dESIGN SUR- FACES

WHITE - VEIN CUT

GREY - VEIN CUT

ALMOND - VEIN CUT

DOLOMIA STONE VEIN CUT

WHITE - VEIN CUT

O5J8	61,0x122,2 cm 24"x48" - RS	B180
O6J3	61,0x122,2 cm 24"x48" - OUTDOOR RS	B182
O4M3	61,0x122,2 cm 24"x48" - LCR	B183
O6J5	30,4x61,0 cm 12"x24" - RS	C110
O5U9	61,0x122 cm 24"x48" - FP-E RS	A184



GREY - VEIN CUT

O5J9	61,0x122,2 cm 24"x48" - RS	B180
O6J2	61,0x122,2 cm 24"x48" - OUTDOOR RS	B182
O4M4	61,0x122,2 cm 24"x48" - LCR	B183
O6J6	30,4x61,0 cm 12"x24" - RS	C110



ALMOND - VEIN CUT

O6J0	61,0x122,2 cm 24"x48" - RS	B180
O6J1	61,0x122,2 cm 24"x48" - OUTDOOR RS	B182
O4M2	61,0x122,2 cm 24"x48" - LCR	B183
O6J4	30,4x61,0 cm 12"x24" - RS	C110
O5U8	61,0x122 cm 24"x48" - FP-E RS	A184





ALMOND



ALMOND VEIN CUT

Sviluppo grafico / Design development / Développement graphique / Grafische Entwicklung 61,0x122,2 cm 24"x48" RS
 (12 grafiche diverse / 12 different design / 12 graphiques différents / 12 verschiedene Grafische)

m/ floor: WHITE 122,2x122,2 cm RS/48"x48" RS
 wall: ALMOND mosaico monocolor 30x30 cm /12"x12"
 furniture: GREY 61,0x122,2 cm RS/24"x48" RS

DOLOMIA STONE

Decori / Decors / Décors / Dekors

mosaico monocolor 36 tessere 5x5 - 30x30 cm 12"x12" P71



WHITE GREY ALMOND WHITE VEIN CUT GREY VEIN CUT ALMOND VEIN CUT

mosaico esagona monocolor - 30x30 cm 12"x12" P78



WHITE GREY ALMOND

mosaico patchwork monocolor - 30x30 cm 12"x12" P80



WHITE VEIN CUT GREY VEIN CUT ALMOND VEIN CUT



m

Pezzi Speciali / Special Pieces / Pièces Spéciales / Formteile								
	battiscopa 6,5x122,2 cm 2 1/2"x48" RS 10 P05	battiscopa 6,5x122,2 cm 2 1/2"x48" LCR 10 P05A	elemento "L" monolitico outdoor 15x30x4 cm 6"x12"x1 3/4" 4 P50	step 30,4x61,0 cm 12"x24" RS P90	gradino costa retta 34x122,2x4 cm 13"x48"x1 3/4" RS P32	gradino costa retta 34x61,0x4 cm 13"x24"x1 3/4" RS P31	vista frontale angolare costa retta dx/sx 34x122,2x4 cm 13"x48"x1 3/4" RS P41	vista dal retro angolare costa retta dx/sx 34x34x4 cm 13"x13"x1 3/4" RS P40
WHITE	•	•	•	•	•	•	•	•
GREY	•	•	•	•	•	•	•	•
ALMOND	•	•	•	•	•	•	•	•
WHITE VEIN CUT	•	•	•	•	•		•	
GREY VEIN CUT	•	•	•	•	•		•	
ALMOND VEIN CUT	•	•	•	•	•		•	

Note / Notes / Notes / Anmerkungen
 I battiscopa e gli elementi "L" vengono venduti a pz. e a scatola completa. Tutti gli altri pezzi speciali vengono venduti al pezzo. I gradini vengono prodotti solo su ordinazione (tempo minimo di consegna 20 gg lavorativi).
 All skirting and monolithic L elements, priced per piece, are sold in full box. All other special trims are sold by piece. Steps are produced only on request (minimum delivery terms of 20 days).
 Les plinthes et élément "L" sont vendues la pièce et par boîte complète. Les autres pièces spéciales sont vendus la pièce. Le plat de marche sont produit sur demande (délai minimum de 20 jours).
 Die Sockelleisten und Stufen werden pro Stk. und Vollen Kartons verkauft. Stufen und Stufenecken werden nur auf Bestellung produziert (Lieferzeiten mindesten 20 arbeitstagen ab Auftragserteilung).

DOLOMIA STONE

n/ ALMOND FP2 60x90 cm RS/24"x36" RS
o/ WHITE FP2 60x90 cm RS/24"x36" RS



n



o

DOLOMIA STONE VEIN CUT

effetto pietra / stone-look / effet pierre / steinoptik

Colori / Colours / Couleurs / Farben

Formati / Sizes / Formats / Formate

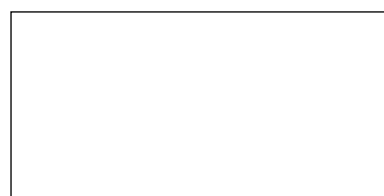

RS - 61,0x122 cm . 24"x48" ± 20 mm FP2 - R11

RS: Rettificato-Strutturato / Rectified-Textured

Formati / Sizes / Formats / Formate	R - 61,0x122 cm 24"x48" ± 20 mm FP2 R11
WHITE VEIN CUT	●
ALMOND VEIN CUT	●



q/ALMOND VEIN CUT FP2
61,0x122 cm RS/24"x48" RS

DOLOMIA STONE VEIN CUT

WHITE - VEIN CUT
O5U9 61,0x122 cm 24"x48" - FP2 RS A184



ALMOND - VEIN CUT
O5U8 61,0x122 cm 24"x48" - FP2 RS A184



Per la disponibilità articolo: www.tuscaniagres.it digitando il codice web segnalato a lato dei formati.
For the item's availability: www.tuscaniagres.it type the web code reported next to the sizes.
Pour vérifier la disponibilité de l'article: www.tuscaniagres.it en saisissant le code web indiqué à coté des formats.
Für die Artikelverfügbarkeit: www.tuscaniagres.it web code eingeben, an der Seite von Formaten angedeutet.

FP2 Pezzi Speciali / Special Pieces / Pièces Spéciales / Formteile	<p>elemento "L" 61x122x5 cm 24"x48" x2" RS</p> <p>P102A</p>	<p>angolare elemento "L" SX/DX 61x61x5 cm 24"x24" x2" RS</p> <p>P105A</p>	<p>griglia 20x61 cm 8"x24" RS</p> <p>P106D</p>	<p>angolo SX angolo DX griglia angolo 20x61 cm 8"x24" RS</p> <p>P109B COPPIA</p>
	WHITE VEIN CUT ALMOND VEIN CUT	● ●	● ●	● ●
	<p>round lineare 30x122 cm 12"x48" RS</p> <p>P112A</p>	<p>angolo SX angolo DX round angolare 30x122 cm 12"x48" RS</p> <p>P113C COPPIA</p>	<p>angolo SX angolo DX angolo bordo toro 30x122 cm 12"x48" RS</p> <p>P117</p>	
	WHITE VEIN CUT ALMOND VEIN CUT	● ●	● ●	● ●

Note - Notes - Notes - Anmerkungen
 I pezzi speciali FP2 vengono venduti al pezzo e solo su ordinazione (tempo minimo di consegna 20 gg lavorativi dall'ordine).
 The special pieces FP2 are sold by piece and only on request (minimum delivery time 20 working days from date of order).
 Les pièces spéciales FP2 sont vendus à la pièce et uniquement sur commande (délai minimum de livraison 20 jours ouvrés à partir de la commande).
 Spezial Teile FP2 sind pro Stück verkauft und nur auf Bestellungen produziert. (Lieferzeiten mindesten 20 arbeitstage ab Auftragbestätigung)

a/ BEIGE 61,0x61,0 cm R-MP/24"x24" R-MP - 30,4x61,0 cm R/12"x24" R



effetto pietra / stone-look / effet pierre / steinoptik



Colori / Colours / Couleurs / Farben



Formati / Sizes / Formats / Formate

	R-MG - 122,2x122,2 cm . 48"x48"	± 9,5 mm	R10
	R-MG - 61,0x122,2 cm . 24"x48"	± 9,5 mm	R10
	RS - 60,0x90,0 cm . 24"x36"	± 20 mm	FP2 - R11
	R-MG - 61,0x61,0 cm . 24"x24"	± 9,5 mm	R10
	R-MP - 61,0x61,0 cm . 24"x24"	± 9,0 mm	R10
	R-MP - 61,0x61,0 cm . 24"x24"	± 9,0 mm	OUTDOOR - R11
	R - 30,4x61,0 cm . 12"x24"	± 9,0 mm	R10
	R - 30,4x61,0 cm . 12"x24"	± 9,0 mm	OUTDOOR - R11
	R - 30,4x30,4 cm . 12"x12"	± 9,0 mm	R10
	R - 30,4x30,4 cm . 12"x12"	± 9,0 mm	OUTDOOR - R11

I formati 122,2x122,2 - 61,0x122,2 - 61,0x61,0 - 30,4x61,0 - 30,4x30,4 sono modulari tra loro. Per schemi di posa vedi pag. 67.

The sizes 122,2x122,2 - 61,0x122,2 - 61,0x61,0 - 30,4x61,0 - 30,4x30,4 are combined laying. For laying patterns see page 67.

Les formats 122,2x122,2 - 61,0x122,2 - 61,0x61,0 - 30,4x61,0 - 30,4x30,4 sont modulaires entre eux. Pour les plans de pose, voir page 67.

Die Formate 122,2x122,2 - 61,0x122,2 - 61,0x61,0 - 30,4x61,0 - 30,4x30,4 sind untereinander modular aufgebaut. Zum Verlegebeispiele siehe Seite 67.

R-MG: Modulo grande rettificato/ Big modul rectified

R-MP: Modulo piccolo rettificato/ Small modul rectified

R: Rettificato/ Rectified

Formati / Sizes / Formats / Formate	R-MG 122,2x122,2 cm 48"x48" ± 9,5 mm	R-MG 61,0x122,2 cm 24"x48" ± 9,5 mm	R-MG 61,0x61,0 cm 24"x24" ± 9,5 mm	R-MP 61,0x61,0 cm 24"x24" ± 9,0 mm	R-MP 61,0x61,0 cm 24"x24" ± 9,0 mm OUTDOOR R11	RS 60,0x90,0 cm 24"x36" ± 20 mm FP2 R11	R 30,4x61,0 cm 12"x24" ± 9,0 mm OUTDOOR	R - 30,4x61,0 cm 12"x24" ± 9,0 mm OUTDOOR	R - 30,4x30,4 cm 12"x12" ± 9,0 mm	R - 30,4x30,4 cm 12"x12" ± 9,0 mm OUTDOOR
	R10	R10	R10	R10	R10 OUTDOOR R11	FP2 R11	R10	R11	R10	R11
IVOIRE	●	●	●	●	●	●	●	●	●	●
GRIS				●	●	●	●	●	●	●
BEIGE				●	●	●	●	●	●	●
GREIGE				●	●	●	●	●	●	●



b/ GRIS 61,0x61,0 cm R-MP/24"x24" R-MP -
 30,4x61,0 cm R/12"x24" R/30,4x30,4 cm R/12"x12" R
 POSA 4

c/ IVOIRE 122,2x122,2 cm R-MG/48"x48" R-MG -
 61,0x122,2 cm R-MG/24"x48" R-MG - 61,0x61,0 cm R-MG/24"x24" R-MG



c



SAINT-MICHEL 63

d-e/ indoor: GREIGE 61,0x61,0 cm R-MP/24"x24" R-MP -
 outdoor: GREIGE FP2 60,0x90,0 cm RS/24"x36" RS



DESIGN SUR- FACES

IVOIRE

GRIS

BEIGE

GREIGE

SAINT-MICHEL

IVOIRE

O1V8	122,2x122,2 cm 48"x48" - R-MG	C230
O0X3	61,0x122,2 cm 24"x48" - R-MG	C182
O5X7	61,0x61,0 cm 24"x24" - R-MG	A196A
O8W4	61,0x61,0 cm 24"x24" - R-MP	A196
O3X1	61,0x61,0 cm 24"x24" OUTDOOR - R	A197
O8W0	30,4x61,0 cm 12"x24" - R	A112
O3X5	30,4x61,0 cm 12"x24" OUTDOOR - R	A113
O7W6	30,4x30,4 cm 12"x12" - R	A101
O3X9	30,4x30,4 cm 12"x12" OUTDOOR - R	A102
O9W5	60,0x90,0 cm 24"x36" - FP-E RS	A179

GRIS

O8W3	61,0x61,0 cm 24"x24" - R-MP	A196
O3X2	61,0x61,0 cm 24"x24" OUTDOOR - R-MP	A197
O7W9	30,4x61,0 cm 12"x24" - R	A112
O3X6	30,4x61,0 cm 12"x24" OUTDOOR - R	A113
O7W5	30,4x30,4 cm 12"x12" - R	A101
O4X0	30,4x30,4 cm 12"x12" OUTDOOR - R	A102
O9W4	60,0x90,0 cm 24"x36" - FP-E RS	A179

BEIGE

O8W1	61,0x61,0 cm 24"x24" - R-MP	A196
O3X3	61,0x61,0 cm 24"x24" OUTDOOR - R-MP	A197
O7W7	30,4x61,0 cm 12"x24" - R	A112
O3X7	30,4x61,0 cm 12"x24" OUTDOOR - R	A113
O7W3	30,4x30,4 cm 12"x12" - R	A101
O4X1	30,4x30,4 cm 12"x12" OUTDOOR - R	A102
O9W2	60,0x90,0 cm 24"x36" - FP-E RS	A179

GREIGE

O8W2	61,0x61,0 cm 24"x24" - R-MP	A196
O3X4	61,0x61,0 cm 24"x24" OUTDOOR - R-MP	A197
O7W8	30,4x61,0 cm 12"x24" - R	A112
O3X8	30,4x61,0 cm 12"x24" OUTDOOR - R	A113
O7W4	30,4x30,4 cm 12"x12" - R	A101
O4X2	30,4x30,4 cm 12"x12" OUTDOOR - R	A102
O9W3	60,0x90,0 cm 24"x36" - FP-E RS	A179

I formati 122,2x122,2 - 61,0x122,2 - 61,0x61,0 - 30,4x61,0 - 30,4x30,4 sono modulari tra loro. Per schemi di posa vedi pag. 67.

The sizes 122,2x122,2 - 61,0x122,2 - 61,0x61,0 - 30,4x61,0 - 30,4x30,4 are combined laying. For laying patterns see page 67.

Les formats 122,2x122,2 - 61,0x122,2 - 61,0x61,0 - 30,4x61,0 - 30,4x30,4 sont modulaires entre eux. Pour les plans de pose, voir page 67.

Die Formate 122,2x122,2 - 61,0x122,2 - 61,0x61,0 - 30,4x61,0 - 30,4x30,4 sind untereinander modular aufgebaut. Zum Verlegebeispiele siehe Seite 67.

Per la disponibilità articolo: www.tuscaniagres.it digitando il codice web segnalato a lato dei formati.
For the item's availability: www.tuscaniagres.it type the web code reported next to the sizes.
Pour vérifier la disponibilité de l'article: www.tuscaniagres.it en saisissant le code web indiqué à coté des formats.
Für die Artikelverfügbarkeit: www.tuscaniagres.it web code eingeben, an der Seite von Formaten angedeutet.



BEIGE

Sviluppo grafico / Design development / Développement graphique / Grafische Entwicklung 61,0x61,0 cm 24"x24" R-MP (20 grafiche diverse / 20 different design / 20 graphiques différents / 20 verschiedene Grafische)

Decor / Decors / Décors / Dekors

mosaico monocolore 36 tessere 5x5 - 30x30 cm 12"x12" P71



IVOIRE

GRIS

BEIGE

GREIGE

Pezzi Speciali / Special Pieces / Pièces Spéciales / Formteile							
	battiscopa 6,5x61,0 cm 2 1/2"x24" R P07	elemento "L" monolitico outdoor 15x30x4 cm 6"x12"x1 3/4" R P50	step 30,4x61,0 cm 12"x24" R P90	gradino costa retta 34x122,2x4 cm 13"x48"x1 3/4" R P32	gradino costa retta 34x61,0x4 cm 13"x24"x1 3/4" R P31	vista frontale angolare costa retta dx/sx 34x122,2x4 cm 13"x48"x1 3/4" R P41	vista dal retro angolare costa retta dx/sx 34x34x4 cm 13"x13"x1 3/4" R P40
IVOIRE	●	●	●	●	●	●	●
GRIS	●	●	●	●	●	●	●
BEIGE	●	●	●	●	●	●	●
GREIGE	●	●	●	●	●	●	●

Note / Notes / Notes / Anmerkungen
 I battiscopa e gli elementi "L" vengono venduti a pz. e a scatola completa. Tutti gli altri pezzi speciali vengono venduti al pezzo. I gradini vengono prodotti solo su ordinazione (tempo minimo di consegna 20 gg lavorativi).
 All skirting and monolithic L elements, priced per piece, are sold in full box. All other special trims are sold by piece. Steps are produced only on request (minimum delivery terms of 20 days).
 Les plinthes et élément "L" sont vendues la pièce et par boîte complète. Les autres pièces spéciales sont vendus la pièce. Le plat de marche sont produit sur demande (délai minimum de 20 jours).
 Die Sockelleisten und Stufen werden pro Stk. und Vollen Kartons verkauft. Stufen und Stufenecken werden nur auf Bestellung produziert (Lieferzeiten mindesten 20 arbeitstagen ab Auftragserteilung).

SAINT-MICHEL

Esempi di posa / Laying compositions / Exemple de pose / Verlegemuster multifornato/ multifornato

1 <table border="1"> <thead> <tr> <th>R-MP</th> <th>R-MG</th> <th></th> </tr> </thead> <tbody> <tr> <td>61x61 - 24"x24"</td> <td>122,2x122,2 - 48"x48"</td> <td>44,45%</td> </tr> <tr> <td>30,4x61 - 12"x24"</td> <td>61x122,2 - 24"x48"</td> <td>44,44%</td> </tr> <tr> <td>30,4x30,4 - 12"x12"</td> <td>61x61 - 24"x24"</td> <td>11,11%</td> </tr> </tbody> </table>	R-MP	R-MG		61x61 - 24"x24"	122,2x122,2 - 48"x48"	44,45%	30,4x61 - 12"x24"	61x122,2 - 24"x48"	44,44%	30,4x30,4 - 12"x12"	61x61 - 24"x24"	11,11%	2 <table border="1"> <thead> <tr> <th>R-MP</th> <th>R-MG</th> <th></th> </tr> </thead> <tbody> <tr> <td>61x61 - 24"x24"</td> <td>122,2x122,2 - 48"x48"</td> <td>57,14%</td> </tr> <tr> <td>30,4x61 - 12"x24"</td> <td>61x122,2 - 24"x48"</td> <td>28,57%</td> </tr> <tr> <td>30,4x30,4 - 12"x12"</td> <td>61x61 - 24"x24"</td> <td>14,29%</td> </tr> </tbody> </table>	R-MP	R-MG		61x61 - 24"x24"	122,2x122,2 - 48"x48"	57,14%	30,4x61 - 12"x24"	61x122,2 - 24"x48"	28,57%	30,4x30,4 - 12"x12"	61x61 - 24"x24"	14,29%	3 <table border="1"> <thead> <tr> <th>R-MP</th> <th>R-MG</th> <th></th> </tr> </thead> <tbody> <tr> <td>61x61 - 24"x24"</td> <td>122,2x122,2 - 48"x48"</td> <td>57,14%</td> </tr> <tr> <td>30,4x61 - 12"x24"</td> <td>61x122,2 - 24"x48"</td> <td>28,57%</td> </tr> <tr> <td>30,4x30,4 - 12"x12"</td> <td>61x61 - 24"x24"</td> <td>14,29%</td> </tr> </tbody> </table>	R-MP	R-MG		61x61 - 24"x24"	122,2x122,2 - 48"x48"	57,14%	30,4x61 - 12"x24"	61x122,2 - 24"x48"	28,57%	30,4x30,4 - 12"x12"	61x61 - 24"x24"	14,29%
R-MP	R-MG																																					
61x61 - 24"x24"	122,2x122,2 - 48"x48"	44,45%																																				
30,4x61 - 12"x24"	61x122,2 - 24"x48"	44,44%																																				
30,4x30,4 - 12"x12"	61x61 - 24"x24"	11,11%																																				
R-MP	R-MG																																					
61x61 - 24"x24"	122,2x122,2 - 48"x48"	57,14%																																				
30,4x61 - 12"x24"	61x122,2 - 24"x48"	28,57%																																				
30,4x30,4 - 12"x12"	61x61 - 24"x24"	14,29%																																				
R-MP	R-MG																																					
61x61 - 24"x24"	122,2x122,2 - 48"x48"	57,14%																																				
30,4x61 - 12"x24"	61x122,2 - 24"x48"	28,57%																																				
30,4x30,4 - 12"x12"	61x61 - 24"x24"	14,29%																																				
4 <table border="1"> <thead> <tr> <th>R-MP</th> <th>R-MG</th> <th></th> </tr> </thead> <tbody> <tr> <td>61x61 - 24"x24"</td> <td>122,2x122,2 - 48"x48"</td> <td>40,00%</td> </tr> <tr> <td>30,4x61 - 12"x24"</td> <td>61x122,2 - 24"x48"</td> <td>40,00%</td> </tr> <tr> <td>30,4x30,4 - 12"x12"</td> <td>61x61 - 24"x24"</td> <td>20,00%</td> </tr> </tbody> </table>	R-MP	R-MG		61x61 - 24"x24"	122,2x122,2 - 48"x48"	40,00%	30,4x61 - 12"x24"	61x122,2 - 24"x48"	40,00%	30,4x30,4 - 12"x12"	61x61 - 24"x24"	20,00%	5 <table border="1"> <thead> <tr> <th>R-MP</th> <th>R-MG</th> <th></th> </tr> </thead> <tbody> <tr> <td>61x61 - 24"x24"</td> <td>122,2x122,2 - 48"x48"</td> <td>36,45%</td> </tr> <tr> <td>30,4x61 - 12"x24"</td> <td>61x122,2 - 24"x48"</td> <td>54,50%</td> </tr> <tr> <td>30,4x30,4 - 12"x12"</td> <td>61x61 - 24"x24"</td> <td>9,05%</td> </tr> </tbody> </table>	R-MP	R-MG		61x61 - 24"x24"	122,2x122,2 - 48"x48"	36,45%	30,4x61 - 12"x24"	61x122,2 - 24"x48"	54,50%	30,4x30,4 - 12"x12"	61x61 - 24"x24"	9,05%	6 <table border="1"> <thead> <tr> <th>R-MP</th> <th>R-MG</th> <th></th> </tr> </thead> <tbody> <tr> <td>61x61 - 24"x24"</td> <td>122,2x122,2 - 48"x48"</td> <td>64,00%</td> </tr> <tr> <td>30,4x61 - 12"x24"</td> <td>61x122,2 - 24"x48"</td> <td>32,00%</td> </tr> <tr> <td>30,4x30,4 - 12"x12"</td> <td>61x61 - 24"x24"</td> <td>4,00%</td> </tr> </tbody> </table>	R-MP	R-MG		61x61 - 24"x24"	122,2x122,2 - 48"x48"	64,00%	30,4x61 - 12"x24"	61x122,2 - 24"x48"	32,00%	30,4x30,4 - 12"x12"	61x61 - 24"x24"	4,00%
R-MP	R-MG																																					
61x61 - 24"x24"	122,2x122,2 - 48"x48"	40,00%																																				
30,4x61 - 12"x24"	61x122,2 - 24"x48"	40,00%																																				
30,4x30,4 - 12"x12"	61x61 - 24"x24"	20,00%																																				
R-MP	R-MG																																					
61x61 - 24"x24"	122,2x122,2 - 48"x48"	36,45%																																				
30,4x61 - 12"x24"	61x122,2 - 24"x48"	54,50%																																				
30,4x30,4 - 12"x12"	61x61 - 24"x24"	9,05%																																				
R-MP	R-MG																																					
61x61 - 24"x24"	122,2x122,2 - 48"x48"	64,00%																																				
30,4x61 - 12"x24"	61x122,2 - 24"x48"	32,00%																																				
30,4x30,4 - 12"x12"	61x61 - 24"x24"	4,00%																																				
7 <table border="1"> <thead> <tr> <th>R-MP</th> <th>R-MG</th> <th></th> </tr> </thead> <tbody> <tr> <td>61x61 - 24"x24"</td> <td>122,2x122,2 - 48"x48"</td> <td>25,00%</td> </tr> <tr> <td>30,4x61 - 12"x24"</td> <td>61x122,2 - 24"x48"</td> <td>50,00%</td> </tr> <tr> <td>30,4x30,4 - 12"x12"</td> <td>61x61 - 24"x24"</td> <td>25,00%</td> </tr> </tbody> </table>	R-MP	R-MG		61x61 - 24"x24"	122,2x122,2 - 48"x48"	25,00%	30,4x61 - 12"x24"	61x122,2 - 24"x48"	50,00%	30,4x30,4 - 12"x12"	61x61 - 24"x24"	25,00%	8 <table border="1"> <thead> <tr> <th>R-MP</th> <th>R-MG</th> <th></th> </tr> </thead> <tbody> <tr> <td>61x61 - 24"x24"</td> <td>122,2x122,2 - 48"x48"</td> <td>66,78%</td> </tr> <tr> <td>30,4x61 - 12"x24"</td> <td>61x122,2 - 24"x48"</td> <td>16,64%</td> </tr> <tr> <td>30,4x30,4 - 12"x12"</td> <td>61x61 - 24"x24"</td> <td>16,58%</td> </tr> </tbody> </table>	R-MP	R-MG		61x61 - 24"x24"	122,2x122,2 - 48"x48"	66,78%	30,4x61 - 12"x24"	61x122,2 - 24"x48"	16,64%	30,4x30,4 - 12"x12"	61x61 - 24"x24"	16,58%	9 <table border="1"> <thead> <tr> <th>R-MP</th> <th>R-MG</th> <th></th> </tr> </thead> <tbody> <tr> <td>61x61 - 24"x24"</td> <td>122,2x122,2 - 48"x48"</td> <td>50,00%</td> </tr> <tr> <td>30,4x61 - 12"x24"</td> <td>61x122,2 - 24"x48"</td> <td>24,90%</td> </tr> <tr> <td>30,4x30,4 - 12"x12"</td> <td>61x61 - 24"x24"</td> <td>25,10%</td> </tr> </tbody> </table>	R-MP	R-MG		61x61 - 24"x24"	122,2x122,2 - 48"x48"	50,00%	30,4x61 - 12"x24"	61x122,2 - 24"x48"	24,90%	30,4x30,4 - 12"x12"	61x61 - 24"x24"	25,10%
R-MP	R-MG																																					
61x61 - 24"x24"	122,2x122,2 - 48"x48"	25,00%																																				
30,4x61 - 12"x24"	61x122,2 - 24"x48"	50,00%																																				
30,4x30,4 - 12"x12"	61x61 - 24"x24"	25,00%																																				
R-MP	R-MG																																					
61x61 - 24"x24"	122,2x122,2 - 48"x48"	66,78%																																				
30,4x61 - 12"x24"	61x122,2 - 24"x48"	16,64%																																				
30,4x30,4 - 12"x12"	61x61 - 24"x24"	16,58%																																				
R-MP	R-MG																																					
61x61 - 24"x24"	122,2x122,2 - 48"x48"	50,00%																																				
30,4x61 - 12"x24"	61x122,2 - 24"x48"	24,90%																																				
30,4x30,4 - 12"x12"	61x61 - 24"x24"	25,10%																																				

SAINT-MICHEL

effetto pietra / stone-look / effet pierre / steinoptik

Colori / Colours / Couleurs / Farben



RS: Rettificato-Strutturato / Rectified-Textured

Formati / Sizes / Formats / Formate	RS - 60,0x90,0 cm 24"x36" ± 20 mm FP2 R11
IVOIRE	●
GRIS	●
BEIGE	●
GREIGE	●



Formati / Sizes / Formats / Formate

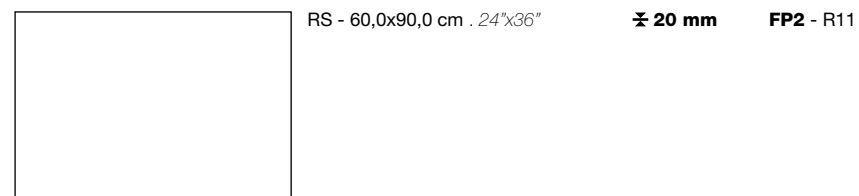

Per la disponibilità articolo: www.tuscaniagres.it digitando il codice web segnalato a lato dei formati.
For the item's availability: www.tuscaniagres.it type the web code reported next to the sizes.
Pour vérifier la disponibilité de l'article: www.tuscaniagres.it en saisissant le code web indiqué à coté des formats.
Für die Artikelverfügbarkeit: www.tuscaniagres.it web code eingeben, an der Seite von Formaten angedeutet.

SAINT-MICHEL



f/GREIGE FP2
60,0x90,0 cm RS/24"x36" RS

FP2 Pezzi Speciali / Special Pieces / Pièces Spéciales / Formteile	elemento "L" 30x90x5 cm 12"x36"x2" RS P102B	angolare elemento "L" SX/DX 30x90x5 cm 12"x36"x2" RS P105B	griglia 20x90 cm 8"x36" RS P106C	angolo SX angolo DX griglia angolo 20x90 cm 8"x36" RS P108 COPPIA
IVOIRE	●	●	●	●
GRIS	●	●	●	●
BEIGE	●	●	●	●
GREIGE	●	●	●	●

	round lineare 30x90 cm 12"x36" RS P112B	angolo SX angolo DX round angolare 30x90 cm 12"x36" RS P113D COPPIA	angolo SX angolo DX angolo bordo toro 30x90 cm 12"x36" RS P118
IVOIRE	●	●	●
GRIS	●	●	●
BEIGE	●	●	●
GREIGE	●	●	●

Note - Notes - Notes - Anmerkungen
I pezzi speciali FP2 vengono venduti al pezzo e solo su ordinazione (tempo minimo di consegna 20 gg lavorativi dall'ordine).
The special pieces FP2 are sold by piece and only on request (minimum delivery time 20 working days from date of order).
Les pièces spéciales FP2 sont vendus à la pièce et uniquement sur commande (délai minimum de livraison 20 jours ouvrés à partir de la commande).
Spezial Teile FP2 sind pro Stück verkauft und nur auf Bestellungen produziert. (Lieferzeiten mindesten 20 arbeitstage ab Auftragbestätigung)

EFFETTO LEGNO/
WOOD-LOOK/
EFFET BOIS/
HOLZOPTIK/

skyline

72



74 SKYLINE

b/ DARK BROWN 26,0x160,0 cm RS/10"x63" RS
c/ floor: NATIVE 26,0x160,0 cm RS/10"x63" RS
 wall: TEAK NATIVE - DARK BROWN 30,4x122,2 cm RS/12"x48" RS
 UNIVERSAL NINFA 61,0x122,2 cm R/24"x48" R



b



c

DESIGN SURFACES

NATIVE

DARK BROWN

WHITE

GREY

NATIVE

O5X1	26,0x160,0 cm	10"x63"	- RS	A90
O0V3	30,4x122,2 cm	12"x48"	- RS	A120
O4X3	30,4x122,2 cm	12"x48"	TEAK - RS	A121
O0V0	20,2x122,2 cm	8"x48"	- RS	A30
O4X8	20,2x122,2 cm	8"x48"	OUTDOOR - RS	A31
O5W1	22x90 cm	9"x36"	- RS	A70
O4W7	15x90 cm	6"x36"	- RS	A20
O6W9	30x122 cm	12"x48"	FP-E RS	A150



DARK BROWN

O5X2	26,0x160,0 cm	10"x63"	- RS	A90
O0V1	30,4x122,2 cm	12"x48"	- RS	A120
O4X4	30,4x122,2 cm	12"x48"	TEAK - RS	A121
O9U8	20,2x122,2 cm	8"x48"	- RS	A30
O4X7	20,2x122,2 cm	8"x48"	OUTDOOR - RS	A31
O4W9	22x90 cm	9"x36"	- RS	A70
O4W5	15x90 cm	6"x36"	- RS	A20



WHITE

O5X3	26,0x160,0 cm	10"x63"	- RS	A90
O0V2	30,4x122,2 cm	12"x48"	- RS	A120
O4X5	30,4x122,2 cm	12"x48"	TEAK - RS	A121
O9U9	20,2x122,2 cm	8"x48"	- RS	A30
O4X9	20,2x122,2 cm	8"x48"	OUTDOOR - RS	A31
O5W0	22x90 cm	9"x36"	- RS	A70
O4W6	15x90 cm	6"x36"	- RS	A20
O9W6	30x122 cm	12"x48"	FP-E RS	A150



GREY

O5X4	26,0x160,0 cm	10"x63"	- RS	A90
O2V1	30,4x122,2 cm	12"x48"	- RS	A120
O4X6	30,4x122,2 cm	12"x48"	TEAK - RS	A121
O2V2	20,2x122,2 cm	8"x48"	- RS	A30
O5X0	20,2x122,2 cm	8"x48"	OUTDOOR - RS	A31
O5W2	22x90 cm	9"x36"	- RS	A70
O4W8	15x90 cm	6"x36"	- RS	A20

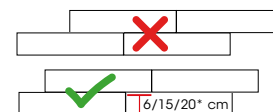

- distanza 6/15/20 cm a correre
- placed 6/15/20 cm apart, one next to another
- distance 6/15/20 cm à joints coupés
- abstand 6/15/20 cm bei fortlaufender Verlegung

Si consiglia la posa sfalsata irregolare del prodotto onde evitare problemi di planarità.
 Si consiglia inoltre l'utilizzo dei distanziatori livellanti.
 It is advisable to stagger the product irregularly when laying it to avoid problems in flatness.
 We also recommend the use of leveling wedges.
 Nous vous conseillons d'adopter la pose irrégulière à joints décalés pour le produit a fin d'éviter les problèmes de planéité.
 Nous recommandons également l'utilisation des croisillons nivelant.
 Empfehlen wir die unregelmäßige versetzte Verlegung dieser Fliese, um Probleme mit der Ebenflächigkeit zu vermeiden.
 Wir empfehlen auch die Verwendung von nivellierenden Abstandhaltern.

Per la disponibilità articolo: www.tuscaniagres.it digitando il codice web segnalato a lato dei formati.
 For the item's availability: www.tuscaniagres.it type the web code reported next to the sizes.
 Pour vérifier la disponibilité de l'article: www.tuscaniagres.it en saisissant le code web indiqué à côté des formats.
 Für die Artikelverfügbarkeit: www.tuscaniagres.it web code eingeben, an der Seite von Formaten angedeutet.

d/ floor: GREY 20,2x122,2 cm RS/8"x48" RS
 wall: TEAK GREY 30,4x122,2 cm RS/12"x48" RS
 LE RESINE CENERE 122,2x122,2 cm RS/ 48"x48" RS



Decori / Decors / Décors / Dekors

teak - 9 bacchette

TEAK NATIVE

O4X3 30,4x122,2 cm 12"x48" TEAK - RS A121



TEAK DARK BROWN

O4X4 30,4x122,2 cm 12"x48" TEAK - RS A121



TEAK WHITE





O4X5 30,4x122,2 cm 12"x48" TEAK - RS A121

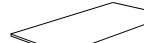

TEAK GREY

O4X6 30,4x122,2 cm 12"x48" TEAK - RS A121

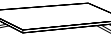

Pezzi Speciali / Special Pieces / Pièces Spéciales / Formteile					
	battiscopa 6,5x122,2 cm 2 1/2"x48" RS  P05	elemento "L" monolitico outdoor 15x30x4 cm 6"x12"x1 3/4"  P50	gradino costa retta 34x122,2x4 cm 13"x48"x1 3/4" RS P32	vista frontale angolare costa retta dx/sx 34x122,2x4 cm 13"x48"x1 3/4" RS P41	vista dal retro
NATIVE	●	●	●	●	●
DARK BROWN	●	●	●	●	●
WHITE	●	●	●	●	●
GREY	●	●	●	●	●

Note / Notes / Notes / Anmerkungen

I battiscopa e gli elementi "L" vengono venduti a pz. e a scatola completa. Tutti gli altri pezzi speciali vengono venduti al pezzo. I gradini vengono prodotti solo su ordinazione (tempo minimo di consegna 20 gg lavorativi).
 All skirting and monolithic L elements, priced per piece, are sold in full box. All other special trims are sold by piece. Steps are produced only on request (minimum delivery terms of 20 days).
 Les plinthes et élément "L" sont vendues la pièce et par boîte complète. Les autres pièces spéciales sont vendus la pièce. Le plat de marche sont produit sur demande (délai minimum de 20 jours).
 Die Sockelleisten und Stufen werden pro Stk. und Vollen Kartons verkauft. Stufen und Stufenecken werden nur auf Bestellung produziert (Lieferzeiten mindesten 20 arbeitstagen ab Auftragserteilung).

effetto legno / wood-look / effet bois / holzoptik

Colori / Colours / Couleurs / Farben

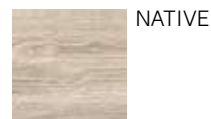

NATIVE



WHITE

RS: Rettificato-Strutturato / Rectified-Textured

Formati / Sizes / Formats / Formate	RS - 30x122 cm 12"x48" ± 20 mm FP2 R11
NATIVE	●
WHITE	●



Formati / Sizes / Formats / Formate

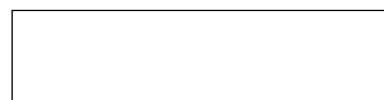

RS - 30x122 cm . 12"x48" ± 20 mm FP2 - R11

Per la disponibilità articolo: www.tuscaniagres.it digitando il codice web segnalato a lato dei formati.
For the item's availability: www.tuscaniagres.it type the web code reported next to the sizes.
Pour vérifier la disponibilité de l'article: www.tuscaniagres.it en saisissant le code web indiqué à coté des formats.
Für die Artikelverfügbarkeit: www.tuscaniagres.it web code eingeben, an der Seite von Formaten angedeutet.

NATIVE

O6W9 30x122 cm 12"x48" FP2 RS A150



WHITE

O9W6 30x122 cm 12"x48" FP2 RS A150



e/NATIVE FP2
30x122 cm RS/12"x48" RS

FP2 Pezzi Speciali / Special Pieces / Pièces Spéciales / Formteile				
	elemento "L" 30x122x5 cm 12"x48" x2" RS	angolare elemento "L" SX/DX 30x122x5 cm 12"x48" x2" RS	griglia 30x61 cm 12"x24" RS	angolo SX angolo DX griglia angolo 30x61 cm 12"x24" RS
	P102	P105	P106B	P109A COPPIA
NATIVE	●	●	●	●
WHITE	●	●	●	●
	round lineare 30x122 cm 12"x48" RS	round angolare 30x122 cm 12"x48" RS	angolo SX angolo DX angolo bordo toro 30x122 cm 12"x48" RS	
	P112A	P113C COPPIA	P116	
NATIVE	●	●	●	
WHITE	●	●	●	

Note - Notes - Notes - Anmerkungen
I pezzi speciali FP2 vengono venduti al pezzo e solo su ordinazione (tempo minimo di consegna 20 gg lavorativi dall'ordine).
The special pieces FP2 are sold by piece and only on request (minimum delivery time 20 working days from date of order).
Les pièces spéciales FP2 sont vendus à la pièce et uniquement sur commande (délai minimum de livraison 20 jours ouvrés à partir de la commande).
Spezial Teile FP2 sind pro Stück verkauft und nur auf Bestellungen produziert. (Lieferzeiten mindesten 20 arbeitstage ab Auftragbestätigung)

QUANDO LA SOSTENIBILITÀ DIVENTA UNA CERTEZZA RICONOSCIUTA/

Le piastrelle in gres porcellanato di Tuscania hanno ottenuto la certificazione internazionale **ISO 17889-1 "Sustainability issues for ceramic tiling systems"**. La norma definisce uno **standard unico e internazionale** sulla sostenibilità dei prodotti ceramici misurando in maniera oggettiva l'impatto ambientale, economico e sociale delle piastrelle in ceramica lungo il loro ciclo di vita, dalle materie prime fino allo smaltimento, valutando anche parametri di sicurezza e salute dei dipendenti.

Tuscania porcelain stoneware tiles are internationally certified to **ISO 17889-1 "Sustainability issues for ceramic tiling systems"**. The standard establishes a **single international benchmark** for the sustainability of ceramic products by objectively measuring the environmental, economic and social impact of ceramic tiles throughout their life-cycle, from raw materials to disposal, while also assessing workers' health and safety parameters.

Les carreaux en grès cérame Tuscania ont obtenu la certification internationale **ISO 17889-1 "Sustainability issues for ceramic tiling systems"**. La norme définit un **standard unique et international** sur la durabilité des produits céramiques en mesurant objectivement l'impact environnemental, économique et social des carreaux de céramique tout au long de leur cycle de vie, des matières premières à l'élimination en évaluant également les paramètres de santé et de sécurité des employés.

Die Feinsteinzeugfliesen von Tuscania haben die internationale Zertifizierung **ISO 17889-1 "Sustainability issues for ceramic tiling systems"** erhalten. Die Norm definiert einen **einheitlichen internationalen Standard** für die Nachhaltigkeit keramischer Produkte, indem sie die ökologischen, wirtschaftlichen und sozialen Auswirkungen keramischer Fliesen während ihres gesamten Lebenszyklus - von den Rohstoffen bis zur Entsorgung - objektiv misst und dabei auch die Gesundheits- und Sicherheitsparameter der Arbeitnehmer bewertet.



I VANTAGGI DELLA ISO 17889-1
Sul mercato globale dei materiali per edilizia e costruzione sono presenti molte etichette ambientali di prodotto e sistemi di rating degli edifici, con criteri di applicazione che differiscono da paese a paese. La **norma internazionale ISO 17889-1** promuove uno standard che semplifica il quadro generale, uniformando i criteri di valutazione e punteggio. In questo modo le aziende ceramiche di tutto il mondo dispongono di una metodologia per valorizzare le proprie performance ambientali lungo tutta la filiera produttiva e le buone pratiche attuate a livello aziendale. Inoltre **progettisti, appaltatori e clienti finali dispongono di uno strumento verificabile e obiettivo** per evitare le trappole del **greenwashing** e **identificare piastrelle davvero sostenibili**.

THE BENEFITS OF ISO 17889-1
There are many environmental product labels and building rating systems in the global construction and building materials market, with application criteria that vary from country to country. The **international standard ISO 17889-1** promotes a standard that simplifies the overall picture by standardising the assessment and rating criteria. This provides ceramics companies around the world with a methodology for improving environmental performance and good business practices throughout their supply chain. It also provides, **designers, contractors, and end users with a verifiable, objective tool** to avoid greenwashing traps and **identify truly sustainable files**.

A CONTRIBUTION TO THE UN 2030 AGENDA
ISO 17889-1 also promotes the careful use of natural resources and the reduction of waste, as well as greater transparency from companies about the sustainability of their production. This is why it is in line with Goal 12 of the Sustainable Development Goals of the United Nations 2030 Agenda for responsible consumption and production.

UN CONTRIBUTO PER L'AGENDA ONU 2030
La norma ISO 17889-1 favorisce inoltre un uso attento delle risorse naturali e la riduzione di scarti, oltre a garantire una maggiore trasparenza da parte delle imprese sulla sostenibilità della loro produzione. Per questo è in linea con il requisito 12 degli Obiettivi di Sviluppo Sostenibile dall'Agenda 2030 delle Nazioni Unite per il consumo e la produzione responsabili.

LES AVANTAGES DE L'ISO 17889-1
Il existe de nombreux labels environnementaux de produits et de systèmes de notation des bâtiments sur le marché mondial des matériaux de construction, avec des critères d'application différents d'un pays à l'autre. La norme **internationale ISO 17889-1** promeut un standard qui simplifie le cadre général, en normalisant les critères d'évaluation et de notation. De cette manière, les entreprises de céramique du monde entier disposent d'une méthode pour améliorer leurs performances environnementales tout au long de la chaîne de production et leurs bonnes pratiques au niveau de l'entreprise. De plus les concepteurs, les entrepreneurs et **les clients disposent d'un outil vérifiable et objectif** pour éviter les pièges du **greenwashing** et **identifier les carreaux véritablement durables**.

UNE CONTRIBUTION À L'AGENDA 2030 DE L'ONU
La norme ISO 17889-1 favorise également une utilisation prudente des ressources naturelles et la réduction des déchets, ainsi qu'une plus grande transparence des entreprises sur la durabilité de leur production. Pour cela, elle est conforme à l'exigence 12 des Objectifs de Développement Durable de l'Agenda 2030 des Nations Unies pour une consommation et une production responsables.

DIE VORTEILE DER ISO 17889-1
Auf dem Weltmarkt für Bau- und Konstruktionsmaterialien gibt es zahlreiche Umweltzeichen für Produkte und Bewertungssysteme für Gebäude, deren Anwendungskriterien sich von Land zu Land unterscheiden. Die **internationale Norm ISO 17889-1** fördert einen Standard, der den allgemeinen Rahmen durch die Standardisierung von Bewertungs- und Einstufungskriterien vereinfacht. Damit verfügen Keramikunternehmen auf der ganzen Welt über eine Methodik zur Aufwertung ihrer Umweltleistung in der gesamten Produktionskette und der auf Unternehmensebene umgesetzten bewährten Verfahren. Außerdem haben **Planer, Auftragnehmer und Endkunden ein überprüfbares und objektives Instrument**, um **Greenwashing**-Fallen zu vermeiden und **wirklich nachhaltige Fliesen zu erkennen**.

EIN BEITRAG ZUR UNO-AGENDA 2030
Die Norm ISO 17889-1 fördert auch den schonenden Umgang mit natürlichen Ressourcen und die Reduzierung von Abfällen und sorgt für mehr Transparenz der Unternehmen hinsichtlich der Nachhaltigkeit ihrer Produktion. Sie steht daher im Einklang mit der Anforderung 12 der Ziele für nachhaltige Entwicklung der UNO-Agenda 2030 für verantwortungsvollen Konsum und verantwortungsvolle Produktion.

WHEN SUSTAINABILITY BECOMES A RECOGNISED CERTAINTY/ QUAND LA DURABILITÉ DEVIENT UNE CERTITUDE RECONNUE/ WENN NACHHALTIGKEIT ZU EINER ANERKANNTEN GEWISSEIT WIRD

CHI È CONFORME ALLA NORMA
Con la ISO 17889-1 le aziende ceramiche possono attestare la sostenibilità dei loro prodotti se i propri prodotti sono conformi ai valori richiesti dalla norma. **La norma prevede trentotto parametri a cui è obbligatorio essere conformi e che determinano un punteggio specifico per ogni prodotto, confrontandolo con valori di riferimento. Solo le piastrelle in ceramica che raggiungono un punteggio minimo di 117,5 possono ottenere la certificazione ISO 17889-1.**

Tuscania ha raggiunto il punteggio di 128 rispondendo ai requisiti previsti dalla norma ISO 17889-1 rispettando una serie di azioni e provvedimenti portati avanti lungo l'intero ciclo di vita del prodotto:

CRITERI AMBIENTALI
- **Approvvigionamento di materie prime locali recuperate o estratte entro un raggio di 800 km, registrate con relativa scheda di sicurezza.** Oltre il 70% delle materie prime di Tuscania è recuperato o estratto entro un raggio di 800 km;

- **Contenuto di rifiuti riciclati nei prodotti.** Tuscania ha svariate linee di prodotto con oltre al 60% di scarti recuperati e pre-consumo, raggiungendo il massimo livello di eccellenza per il contenuto di rifiuti riciclati nel prodotto;

- **Contratto di acquisto di materie prime e servizi ambientali con fornitori che aderiscono a sistemi interni di politica ambientale;**

- **Utilizzo di sistemi per il recupero del calore dei forni di fabbricazione.** Il 100% dei forni di Tuscania ha un sistema di recupero del calore;

- **Uso di energia rinnovabile nella linea produttiva.** Tutti gli stabilimenti di Tuscania raggiungono il massimo livello di eccellenza nell'uso di energia rinnovabile;

- **Utilizzo di gas naturale negli impianti produttivi;**

- **Monitoraggio dei consumi specifici di combustibile per forni di cottura.** Tutti gli stabilimenti di Tuscania raggiungono il massimo livello di eccellenza nei consumi specifici di combustibili;

- **Monitoraggio delle emissioni in atmosfera di polveri e fluoro.** Tutti gli stabilimenti di Tuscania raggiungono il massimo livello di eccellenza nell'abbattere le emissioni in atmosfera.

- **Riciclo e riutilizzo dei rifiuti di processo.** Tutti gli stabilimenti di Tuscania raggiungono il massimo livello di eccellenza nel riciclo e riutilizzo dei rifiuti di processo con valori pari al 100%;

- **Riciclo dei materiali di imballaggio del prodotto superiore al 50%.** Tutti gli stabilimenti di Tuscania raggiungono il massimo livello di eccellenza nel riciclo dei materiali di imballaggio;

- **Raccolta differenziata e riciclo dei materiali utilizzati per il processo produttivo;**

- **Monitoraggio del consumo specifico di acqua e scarico delle acque reflue durante il ciclo di produzione.** Tutti gli stabilimenti di Tuscania raggiungono il massimo livello di eccellenza nella riduzione dei consumi specifici di acqua e non scaricano acque reflue in quanto vengono interamente riciclate;

- **Utilizzo di imballaggi realizzati con materiali riciclati.** Tutti gli stabilimenti di Tuscania raggiungono il massimo livello di eccellenza in quanto oltre il 70% dei materiali da imballaggio sono riciclati;

- **Guida per l'installazione del prodotto in cantiere contenente disposizioni per una corretta gestione dei rifiuti;**

- **Istruzioni per la manutenzione ordinaria delle piastrelle senza l'utilizzo di prodotti pericolosi e inquinanti;**

- **Linee guida sulla separazione e la gestione dei materiali di scarto per la demolizione delle piastrelle;**

- **Dichiarazione ambientale di prodotto (EPD) di tipo III.**

CRITERI ECONOMICI
- Dimostrazione della conformità del prodotto alle normative applicate dall'azienda.

- I prodotti di Tuscania di prima scelta sono conformi alla norma EN 14411 (ISO 13006).

CRITERI SOCIALI
- Informazione sui rischi di esposizione ad agenti chimici e fisici per i lavoratori;

- Presenza di sistemi di aspirazione e filtraggio polveri nei diversi reparti produttivi;

- Audit periodici sulla salute e sicurezza sul lavoro nella fabbricazione. Tutti gli stabilimenti di Tuscania raggiungono un buon livello di eccellenza nelle verifiche periodiche sulla salute e sicurezza sul lavoro;

- Tuscania raggiunge un buon livello nel rendere disponibile e nel fare utilizzare ai propri dipendenti tutti i dispositivi di protezione individuale necessari per garantire le attività produttive sicure;

- Contratto di acquisto di materie prime e servizi solo con fornitori aventi conformità ai regolamenti e alle leggi in materia di salute, sicurezza e lavoro;

- Informazioni fornite al commerciante e posatore di piastrelle per un corretto e sicuro utilizzo delle piastrelle, del loro imballaggio e taglio;

- Predisposizione di schede di sicurezza del prodotto per il rivenditore e il posatore;

- Informazioni fornite all'utente sull'uso corretto e la manutenzione delle superfici ceramiche.

WHO COMPLIES WITH THE STANDARD
ISO 17889-1 allows ceramics companies to certify the sustainability of their products provided that their products meet the values required by the standard. **The standard identifies thirty-eight parameters that must be met and which determine a specific score for each product by comparing it with reference values. Only ceramic tiles with a minimum score of 117.5 can be certified to ISO 17889-1.**

Tuscania achieved a score of 128, thus meeting the requirements of ISO 17889-1, through a series of actions and measures implemented throughout the product life-cycle:

ENVIRONMENTAL CRITERIA
- **Supply of locally sourced raw materials recycled or extracted within a radius of 800 km, recorded with relevant safety data sheet.** Tuscania recycles or extracts within a radius of 800 km over 70% of the raw materials it uses;

- **Content of recycled waste in products.** Tuscania has a number of product lines with over 60% recycled and pre-consumer waste, achieving the highest level of excellence for the recycled waste content in the product;

- **Contracts for the purchase of raw materials and environmental services with suppliers that implement internal environmental policy systems;**

- **Use of heat recovery systems from production kilns.** 100% of the kilns in Tuscania's plants are equipped with a heat recovery system;

- **Use of renewable energy in the production line.** All Tuscania's plants achieve the highest levels of excellence in the use of renewable energy;

- **Use of natural gas in production facilities;**

- **Monitoring of specific fuel consumption for firing kilns.** All Tuscania's plants achieve the highest levels of excellence in specific fuel consumption;

- **Monitoring of dust and fluorine emissions in the air.** All Tuscania's plants achieve the highest levels of excellence in reducing emissions to the air.

- **Recycling and re-use of process waste.** All Tuscania's plants achieve the highest levels of excellence in the recycling and re-use of process waste with values of 100%;

- **Recycling of more than 50% of the materials used in product packaging.** All Tuscania's plants achieve the highest levels of excellence in the recycling of packaging materials;

- **Separate collection and recycling of materials used in the production process;**

- **Monitoring of specific water consumption and waste water discharge during the production cycle.** All Tuscania's plants achieve the highest levels of excellence in reducing specific water consumption and fully recycle waste water, which is therefore not discharged into the environment;

- **Use of packaging made from recycled materials.** All Tuscania's plants achieve the highest levels of excellence, with over 70% of packaging materials being recycled;

- **Instructions for the installation of the product on the construction site, including provisions for proper waste management;**

- **Instructions for the routine maintenance of tiles without the use of hazardous and polluting products;**

- **Guidelines for the separation and handling of waste materials from the demolition of files;**

- **Type II Environmental Product Declaration (EPD).**

ECONOMIC CRITERIA
- Proof of the conformity of the product with the regulations applied by the company.

- Tuscania top quality products comply with EN 14411 (ISO 13006).

SOCIAL CRITERIA
- Information to workers on the risks of exposure to chemical and physical agents;

- Presence of dust extraction and filtration systems in all the production departments;

- Periodic audits on health and safety in the workplace in manufacturing. All Tuscania's plants achieve a good level of excellence in the periodic health and safety audits;

- Tuscania achieves a good level in the provision and use by its employees of all the personal protective equipment necessary to ensure safe production activities;

- Contracts for the purchase of raw materials and services only with suppliers complying with health, safety and labour regulations and laws;

- Information for tile retailers and layers on the correct and safe use of tiles, their packaging, and cutting;

- Preparation of product safety data sheets for dealers and the layers;

- Information for users on the correct use and maintenance of ceramic surfaces.

QUAND LA DURABILITÉ DEVIENT UNE CERTITUDE RECONNUE/ WENN NACHHALTIGKEIT ZU EINER ANERKANNTEN GEWISSHEIT WIRD

QUI RESPECTE LA NORME

Avec ISO 17889-1, les entreprises de céramique peuvent certifier la durabilité de leurs produits s'ils sont conformes aux valeurs requises par la norme.

La norme prévoit trente-huit paramètres qui doivent être respectés et qui déterminent un score spécifique pour chaque produit, en le comparant à des valeurs de référence. Seuls les carreaux de céramique obtenant un score minimum de 117,5 peuvent obtenir la certification ISO 17889-1.

Tuscania a atteint le score de 128 en répondant aux exigences de la norme ISO 17889-1 et en se conformant à une série d'actions et de mesures menées tout au long du cycle de vie du produit :

CRITÈRES ENVIRONNEMENTAUX

- **Approvisionnement en matières premières locales récupérées ou extraites dans un rayon de 800 km, enregistrées avec la fiche de données de sécurité correspondante.** Plus de 70% des matières premières de Tuscania sont récupérées ou extraites dans un rayon de 800 km ;

- **Teneur en déchets recyclés dans les produits.** Tuscania propose différentes gammes de produits avec plus de 60% de déchets récupérés et de pré-consommation, atteignant le plus haut niveau d'excellence pour la quantité de déchets recyclés dans un produit ;

- **Contrat d'achat de matières premières et de services environnementaux avec des fournisseurs qui adhèrent aux systèmes internes de politique environnementale ;**

- **Utilisation de systèmes de récupération de chaleur pour les fours de fabrication.** 100% des fours Tuscania ont un système de récupération de chaleur ;

- **Utilisation d'énergies renouvelables dans la chaîne de production.** Toutes les usines de Tuscania atteignent le plus haut niveau d'excellence dans l'utilisation d'énergies renouvelables ;

- **Utilisation du gaz naturel dans les usines de production ;**

- **Contrôle de la consommation spécifique de combustible pour les fours de cuisson.** Toutes les usines de Tuscania atteignent le plus haut niveau d'excellence en matière de consommation de carburant spécifique ;

- **Contrôle des émissions de poussières et de fluor dans l'atmosphère.** Toutes les usines de Tuscania atteignent le plus haut niveau d'excellence en matière de réduction des émissions dans l'atmosphère.

- **Processus de recyclage et de réutilisation des déchets.** Toutes les usines de Tuscania atteignent le plus haut niveau d'excellence dans le recyclage et la réutilisation des déchets de processus avec des valeurs égales à 100% ;

- **Recyclage des matériaux d'emballage des produits supérieur à 50%.** Toutes les usines de Tuscania atteignent le plus haut niveau d'excellence dans le recyclage des matériaux d'emballage ;

- **Tri sélectif et recyclage des matériaux utilisés pour le processus de production ;**

- **Contrôle de la consommation d'eau spécifique et des rejets d'eaux usées pendant le cycle de production.** Toutes les usines de Tuscania atteignent le plus haut niveau d'excellence dans la réduction de la consommation d'eau spécifique et ne rejettent pas d'eaux usées car celles-ci sont entièrement recyclées ;

- **Utilisation d'emballages fabriqués avec des matériaux recyclés.** Toutes les usines de Tuscania atteignent le plus haut niveau d'excellence puisque plus de 70% des matériaux d'emballage sont recyclés ;

- **Guide d'installation du produit sur site ayant des dispositions pour une bonne gestion des déchets ;**

- **Instrutions pour l'entretien ordinaire des carreaux sans produits dangereux et polluants ;**

- **Lignes directrices sur la séparation et la gestion des déchets de démolition des carreaux ;**

- **Déclaration environnementale de produit (EPD) de type III.**

CRITÈRES ÉCONOMIQUES

- Démonstration de la conformité des produits aux réglementations appliquées par l'entreprise.

- Les produits Tuscania de premier choix sont conformes à la norme EN 14411 (ISO 13006).

CRITÈRES SOCIAUX

- Informations sur les risques d'exposition aux agents chimiques et physiques pour les travailleurs ;

- Présence de systèmes d'extraction et de filtrage des poussières dans les différents départements de production ;

- Audits périodiques de santé et de sécurité au travail dans la fabrication. Toutes les usines de Tuscania atteignent un bon niveau d'excellence dans les contrôles périodiques de la santé et de la sécurité au travail ;

- Tuscania atteint un bon niveau dans la mise à disposition et l'utilisation par ses employés de tous les équipements de protection individuelle nécessaires pour garantir la sécurité des activités de production ;

- Contrat pour l'achat de matières premières et de services uniquement avec des fournisseurs qui respectent les réglementations et les lois sur la santé, la sécurité et le travail ;

- Informations fournies au commerçant et au poseur de carreaux pour une utilisation correcte et sûre des carreaux, de leur emballage et de leur découpe ;

- Préparation des fiches de données de sécurité des produits pour le détaillant et le poseur ;

- Informations fournies à l'utilisateur sur l'utilisation et l'entretien corrects des surfaces en céramique.

DERFÜLLUNG DER NORM

Mit der ISO 17889-1 können Keramikunternehmen die Nachhaltigkeit ihrer Produkte zertifizieren lassen, wenn ihre Produkte die in der Norm geforderten Werte erfüllen. **Die Norm sieht achtunddreißig Parameter vor, deren Einhaltung obligatorisch ist und die für jedes Produkt eine bestimmte Punktzahl festlegen, die mit Referenzwerten verglichen wird. Nur Keramikfliesen, die eine Mindestpunktzahl von 117,5 erreichen, können die Zertifizierung nach ISO 17889-1 erhalten.**

Tuscania erreichte eine Punktzahl von 128, da es die Anforderungen der ISO 17889-1 durch eine Reihe von Aktionen und Maßnahmen während des gesamten Produktlebenszyklus erfüllte:

UMWELTKRITERIEN

- **Beschaffung von lokalen Rohstoffen, die in einem Umkreis von 800 km gewonnen werden und für die das entsprechende Sicherheitsdatenblatt vorliegt.** Mehr als 70 % der Rohstoffe von Tuscania werden in einem Umkreis von 800 km gewonnen oder abgebaut;

- **Recycelte Abfallstoffe in Produkten.** Tuscania verfügt über mehrere Produktlinien, die zu über 60 % aus wiederverwerteten Abfällen bestehen, und erreicht damit das höchste Exzellenzniveau für den Anteil an recycelten Abfällen im Produkt;

- **Einkaufsverträge für Rohstoffe und Umweltdienstleistungen mit Lieferanten, die sich an die internen umweltpolitischen Systeme halten;**

- **Einsatz von Wärmerückgewinnungssystemen für Produktionsöfen.** 100 % der Öfen in Tuscania sind mit einem Wärmerückgewinnungssystem ausgestattet;

- **Nutzung erneuerbarer Energien in der Produktionslinie.** Alle Werke von Tuscania erreichen das höchste Exzellenzniveau bei der Nutzung erneuerbarer Energien;

- **Einsatz von Erdgas in Produktionsanlagen;**

- **Überwachung des spezifischen Brennstoffverbrauchs für Öfen.** Alle Werke von Tuscania erreichen beim spezifischen Kraftstoffverbrauch das höchste Exzellenzniveau;

- **Überwachung von Feinstaub- und Fluoremissionen in die Atmosphäre.** Alle Werke von Tuscania erreichen ein höchstes Exzellenzniveau bei der Verringerung der atmosphärischen Emissionen.

- **Recycling und Wiederverwendung von Prozessabfällen.** Alle Werke von Tuscania erreichen mit Werten von 100 % das höchste Exzellenzniveau bei Recycling und Wiederverwendung von Prozessabfällen;

- **Recycling von Produktverpackungen von mehr als 50 %.** Alle Werke von Tuscania erreichen das höchste Exzellenzniveau beim Recycling von Verpackungsmaterialien;

- **Abfalltrennung und Recycling der im Produktionsprozess verwendeten Materialien;**

- **Überwachung des spezifischen Wasserverbrauchs und der Abwasserentsorgung während des Produktionszyklus.** Alle Werke von Tuscania erreichen das höchste Exzellenzniveau bei der Reduzierung des spezifischen Wasserverbrauchs und leiten kein Abwasser ein, da es vollständig recycelt wird;

- **Verwendung von Verpackungen aus recycelten Materialien.** Alle Werke von Tuscania erreichen das höchste Exzellenzniveau, da mehr als 70 Prozent der Verpackungsmaterialien recycelt werden;

- **Leitfaden für die Installation des Produkts auf der Baustelle mit Vorschriften für die korrekte Abfallentsorgung;**

- **Anweisungen für die routinemäßige Pflege von Fliesen ohne Verwendung gefährlicher und umweltschädlicher Produkte;**

- **Leitlinien für die Trennung und Handhabung von Abfällen aus dem Abbruch von Fliesen;**

- **Typ III Umweltproduktdeklaration (EPD).**

WIRTSCHAFTLICHE KRITERIEN

- Nachweis der Konformität des Produkts mit den vom Unternehmen angewandten Normen.

- Die Produkte der ersten Wahl von Tuscania entsprechen der Norm EN 14411 (ISO 13006).

SOZIALE KRITERIEN

- Informationen über die Risiken der Exposition gegenüber chemischen und physikalischen Einwirkungen für Arbeitnehmer;

- Vorhandensein von Absaug- und Filtersystemen in den verschiedenen Produktionsabteilungen;

- Regelmäßige Audits zu Gesundheit und Sicherheit am Arbeitsplatz in der Produktion. Alle Werke von Tuscania erreichen bei den regelmäßigen Audits zu Sicherheit und Gesundheitsschutz am Arbeitsplatz ein gutes Niveau;

- Tuscania erreicht ein gutes Niveau bei der Bereitstellung und Verwendung aller persönlichen Schutzausrüstungen für seine Mitarbeiter, die erforderlich sind, um sichere Produktionstätigkeiten zu gewährleisten;

- Verträge für den Kauf von Rohstoffen und Dienstleistungen nur mit Lieferanten, die die Gesundheits-, Sicherheits- und Arbeitsvorschriften und -gesetze einhalten;

- Informationen für Fliesenhändler und Fliesenleger zur korrekten und sicheren Verwendung von Fliesen, deren Verpackung und Zuschnitt;

- Bereitstellung von Produktsicherheitsdatenblättern für den Händler und den Fliesenleger;

- Informationen für den Benutzer über die richtige Verwendung und Pflege von Keramikoberflächen.

rivestimenti /
wall tiles / faiences / Wandfliesen /

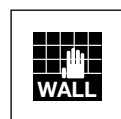

super breaking strength
20 mm. outdoor italian porcelain pavers



stampa digitale /
digital print / haute definition / Digitaltechnik /

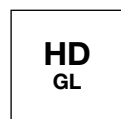



resistenza allo scivolamento DIN 51130 / sliding resistance
DIN 51130 / résistance au glissement DIN 51130 /
gleitwiderstands DIN 51130 /



aspetto della superficie - stonalizzazione / surface appearance /
aspect de la surface / oberflächenaussehen /

V1 **V1/LOW**
 Aspetto uniforme
Uniform appearance
Aspect uniforme
Einheitliches Aussehen

V3 **V3/HIGH**
 Moderata variazione
Moderate variations
Variation modérée
Mäßige Abweichung

V2 **V2/MODERATE**
 Lieve variazione
Slight variations
Légère variation
Leichte Abweichung

V4 **V4/RANDOM**
 Forte stonalizzazione
Substantial variations
Effet dénuancé très accentué
Starkes Farbspiel

pavimenti /
floor tiles / carrelage sol /- Bodenfliesen /

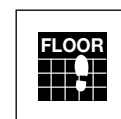

super easy clean
nanotecno / grani



Superfici facilmente pulibili, sicure dal punto di vista della scivolosità e morbide al tatto il tutto ottenute tramite l'applicazione di innovative nanograniglie miscelate nello smalto.

Surfaces that are easy to clean, safe from the point of view of slipperiness and soft to the touch, all obtained through the application of innovative nano-grains mixed in the enamel.

ingelivo /
no frost / ingelifs / Frostsicher /



resistenza allo scivolamento DIN 51097 / sliding resistance
DIN 51097 / résistance au glissement DIN 51097 /
gleitwiderstands DIN 51097 /



IT - La diversità di grafica e la naturale stonalizzazione delle piastrelle costituiscono la caratteristica propria delle serie. Si consiglia di miscelare le varie scatole durante la posa e di scegliere le piastrelle da diversi colli per evitare il ripetersi della stessa grafica accostata.

EN - The different graphics and the natural shading of each tile are intentional characteristics of the range. When laying tiles, we recommend mixing the various boxes and choosing tiles from different boxes, in order to avoid placing tiles with identical graphics adjacent to each other.



FR - La diversité graphique et la variété de tonalités naturelle des carreaux caractérisent de la série. Il est recommandé de mélanger les carreaux de différentes boîtes au cours de la pose et de les choisir dans différents colis pour éviter que les mêmes dessins ne se trouvent côte à côte.

DE - Die unterschiedlichen Maserungen und der natürlichen Farbspiel sind gewollten Eigenschaften der Serie. Bei der Verlegung es wird empfohlen Fliesen aus verschiedenen Kartons zu mischen.

LEGENDA / Legend / Légend / Zeichenerklärung

TABELLA PESI ED IMBALLI

Sizes weight and packaging / Mesures poids et emballages / Tabelle der Gewichte und Verpackungen

formati / sizes / tailles / formate /		pz. x box	mq. x box	box x pal.	mq. x pal.	kg. x mq	kg. x box	kg. x pal.	
NATURALI / NATURAL (N)									
61,5x61,5 cm 24"x24" N	9 mm	4	1,51	30	45,30	20,46	30,90	940	80x120x75
30,8x61,5 cm 12"x24" N	9 mm	7	1,32	40	52,80	18,62	24,57	995	80x120x75
20x20 cm 8"x8" N (agadir)	7,2 mm	38	1,52	60	91,20	15,65	23,78	1440	80x120x95
15,1x30,6 cm 6"x12" N (terraforte, tribeca, tuscolana)	8,5 mm	32	1,48	60	88,80	16,53	24,45	1480	80x120x105
RETTIFICATI / RECTIFIED (R) -									
122,2x122,2 cm 48"x48" R	9,5 mm	2	2,99	18	53,82	21,09	63,05	1175	124x143x60
90x90 cm 36"x36" R	9,5 mm	2	1,62	21	34,02	19,96	32,33	700	94x107x65
80x80 cm 32"x32" R - NEW									
61x122,2 cm 24"x48" R	9,5 mm	2	1,49	36	53,64	20,52	30,57	1120	94x120x75
61x61 cm 24"x24" R	9 mm	4	1,49	30	44,70	19,80	29,50	900	80x120x75
30,4x122,2 cm 12"x48" R	9,5 mm	4	1,49	36	53,64	19,98	29,77	1090	94x120x75
30,4x122,2 cm 12"x48" R TEAK	9,5 mm	2	0,74	57	42,18	19,98	14,79	1153	94x120x65
30,4x61 cm 12"x24" R	9 mm	7	1,30	40	52,00	19,83	25,77	1045	80x120x75
30,4x30,4 cm 12"x12" R	9 mm	13	1,20	40	48,00	20,78	24,93	1010	80x120x75
26x160 cm 10"x63" R	9,5 mm	4	1,66	27	44,82	21,08	35,00	950	91x171x60
22x90 cm 9"x36" R	9 mm	5	0,99	66	65,34	20,02	19,81	1325	94x120x85
20,2x122,2 cm 8"x48" R	9,5 mm	4	0,99	48	47,52	20,33	20,12	980	80x120x75
15x90 cm 6"x36" R	9,5 mm	8	1,08	56	60,48	19,30	20,84	1185	94x120x75
LAPPATI E RETTIFICATI / HONED AND RECTIFIED (LR) - LAPPATO IN CRESTA E RETTIFICATO / SEMI-POLISHED AND RECTIFIED (LCR)									
122,2x122,2 cm 48"x48" LCR	9,5 mm	2	2,99	18	53,82	21,09	63,05	1175	124x143x60
121x121 cm 48"x48" LR	9,5 mm	1	1,46	32	46,72	23,00	33,58	1120	124x143x60
61x122,2 cm 24"x48" LCR	9,5 mm	2	1,49	36	53,64	20,52	30,57	1120	94x120x75
60x121 cm 24"x48" LR	9,5 mm	2	1,45	36	52,20	23,07	33,46	1220	94x120x75
61x61 cm 24"x24" LCR	9 mm	4	1,49	30	44,70	19,80	29,50	900	80x120x75
60x60 cm 24"x24" LR	9,5 mm	4	1,44	30	43,20	23,07	33,22	1010	80x120x75
30,2x60 cm 12"x24" LR	9,5 mm	7	1,27	40	50,80	21,20	26,92	1090	80x120x75
SPESSORATI / EXTRA THICK (R) 									
122x122 cm 48"x48" R	20 mm	1	1,49	18	26,82	43,81	65,27	1215	124x143x60
90x90 cm 36"x36" R	20 mm	1	0,81	21	17,01	42,45	34,38	750	94x107x65
61x122 cm 24"x48" R	20 mm	1	0,74	36	26,64	44,00	32,56	1190	94x120x75
61x61 cm 24"x24" R	20 mm	2	0,74	30	22,20	44,05	32,59	990	80x120x75
60x90 cm 24"x36" R	20 mm	1	0,54	45	24,30	43,50	23,50	1075	94x120x75
40x122 cm 16"x48" R	20 mm	2	0,98	21	20,58	44,15	43,26	925	94x120x55
30x122 cm 12"x48" R	20 mm	2	0,73	36	26,28	41,50	30,29	1117	94x120x74
pezzi speciali / special pieces / pièces spéciales / formteile /									
7,5x61,5 cm 3"x24" battiscopa		12					8,50		
7,5x61 cm 3"x24" battiscopa rettificato		12					8,50		
7,5x30,6 cm 3"x12" battiscopa		36					13,00		
6,5x160 cm 2"x63" battiscopa rettificato		6					14,00		
6,5x122,2 cm 2"x48" battiscopa rettificato		10					12,50		
6,5x121 cm 2"x48" battiscopa lappato rettificato		10					12,50		
6,5x61 cm 2"x24" battiscopa rettificato		12					8,50		











Note / Notes / Notes / Anmerkungen /

I battiscopa e gli elementi "L" vengono venduti a pz. e a scatola completa. Tutti gli altri pezzi speciali vengono venduti al pezzo. I gradini vengono prodotti solo su ordinazione (tempo minimo di consegna 20 gg lavorativi).
All skirting and monolithic L elements, priced per piece, are sold in full box. All other special trims are sold by piece. Steps are produced only on request (minimum delivery terms of 20 days).
Les plinthes et élément "L" sont vendues la pièce et par boîte complète. Les autres pièces spéciales sont vendus la pièce. Le plat de marche sont produit sur demande (délai minimum de 20 jours).
Die Sockelleisten und Stufen werden pro Stk. und Vollen Kartons verkauft. Stufen und Stufenecken werden nur auf Bestellung produziert (Lieferzeiten mindesten 20 arbeitstagen ab Auftragserteilung).

SIMBOLOGIA CARATTERISTICHE TECNICHE - GRÈS PORCELLANATO /

Symboles technical characteristics - porcelain stoneware / Symboles des caracteristiques techniques - grès cérame / Symbole technischen eigenschaften - feinsteinzeug



	CARATTERISTICHE TECNICHE TECHNICAL CHARACTERISTICS CARACTÉRISTIQUES TECHNIQUES TECHNISCHE MERKMALE	NORMA DI RIFERIMENTO REFERENCE STANDARD NORME DE REFERENCE PRÜFMETHODE	VALORE RICHIESTO REQUIRED VALUE VALEUR REQUISE SOLLWERT	VALORE MEDIO TUSCANIA AV. TUSCANIA VALUE VALEUR MOYENNE TUSCANIA MITTLERER TUSCANIA-WERT
	DIMENSIONI DIMENSIONS DIMENSIONS ABMESSUNGEN	ISO 10545-2	CONFORME COMPLIANT CONFORME KONFORM	CONFORME COMPLIANT CONFORME KONFORM
	ASSORBIMENTO D'ACQUA WATER ABSORPTION ABSORPTION D'EAU WASSERAUFNAHME	ISO 10545-3	≤ 0,5 %	CONFORME COMPLIANT CONFORME KONFORM
	RESISTENZA A FLESSIONE MODULUS OF RUPTURE RESISTANCE A LA FLEXION BIEGEFESTIGKEIT	ISO 10545-4	MODULUS OF RUPTURE R ≥35 N/MM ² BREAKING STRENGTH S ≥1300 N	CONFORME COMPLIANT CONFORME KONFORM
	RESISTENZA ALL'ABRASIONE ABRASION RESISTANCE RÉSISTANCE À L'ABRASION ABRIEBBESTÄNDIGKEIT	ISO 10545-7	PEI SOLO PER PIASTRELLE SMALTATE ONLY FOR GLAZED TILES	
	DILATAZIONE TERMICA LINEARE LINEAR THERMAL EXPANSION DILATATION THERMIQUE LINEAIRE LINEARE WÄRMEAUSDEHNUNG	ISO 10545-8	≤ 9x10 ⁻⁵ °C ⁻¹	CONFORME COMPLIANT CONFORME KONFORM
	RESISTENZA AGLI SBALZI TERMICI THERMAL SHOCK RESISTANCE RESISTANCE AUX ECARTS DE TEMPERATURE ITEMPERATURWECHSELBESTÄNDIGKEIT	ISO 10545-9	RESISTENTE RESISTANT RESISTANT BESTÄNDIG	RESISTENTE RESISTANT RESISTANT BESTÄNDIG
	RESISTENZA AL GELO FROST RESISTANCE RESISTANCE AU GEL FROSTBESTÄNDIGKEIT	ISO 10545-12	RESISTENTE RESISTANT RESISTANT BESTÄNDIG	RESISTENTE RESISTANT RESISTANT BESTÄNDIG
	RESISTENZA AGLI ACIDI ED ALLE BASI ACID AND ALKALI RESISTANCE RESISTANCE AUX ACIDES ET AUX BASES SÄURE- UND LAUGENBESTÄNDIGKEIT	ISO 10545-13	CLASS GB MIN.	LOW CONCENTRATION GLA HIGH CONCENTRATION GHA
	RESISTENZA ALL'ATTACCO CHIMICO CHEMICAL RESISTANCE RESISTANCE À L'ATTAQUE CHEMIQUE CHEMISCHE BESTÄNDIGKEIT	ISO 10545-13	CLASS GB MIN.	GA
	RESISTENZA ALLE MACCHIE STAIN RESISTANCE RESISTANCE AU TACHES FLECKENBESTÄNDIGKEIT	ISO 10545-14	CLASS 3 MIN.	5
	COEFFICIENTE DI ATTRITO (SCIVOLOSITÀ) FRICTION COEFFICIENT (SLIPPERINESS) COEFFICIENT DE FRICTION (GLISSEMENT) REIBUNGSKOEFFIZIENT (RUTSCHIGKEIT)	BCR - ITALIA DM DEL 14-06-89	ASTM - USA ASTM C1028	DIN - GERMANIA DIN 51130
		DRY RUBBER 0,62	WET RUBBER 0,51	DRY LEATHER 0,62
			DRY NEOLYTHE 0,69	WET NEOLYTHE 0,62
				R9 - R11 ZH 1/571

THE PRODUCTS HAVING AN ABSORPTION < 0,5% ARE CLASSIFIED ACCORDING THE UNI CEN STANDARDS "FULLY VITRIFIED TILES" AND ACCORDING TO THE ASTM STANDARDS "IMPERVIOUS TILES"

CERSAIE / 2023

Le informazioni contenute nel presente catalogo sono il più possibile esatte, ma non sono da ritenersi vincolanti.

Per esigenze di produzione l'Azienda si riserva il diritto di apportare eventuali modifiche che si rendessero necessarie.

Peso, colori e misure sono soggetti alle inevitabili variazioni tipiche del processo di cottura della ceramica. I colori e gli effetti riportati sul presente catalogo sono indicativi per i limiti consentiti dalla stampa; per questo non possono essere vincolanti e costituire base per eventuali contestazioni.

The information contained in this catalogue is as accurate as possible, but cannot be considered as legally binding.

The Company reserves the right to make any modifications that become necessary due to production requirements.

Weight, colours and dimensions are subject to the inevitable variations typical of the ceramic firing process. Colours and aesthetic effects shown on this catalogue should be considered indicative and approximate as a result of printing process limits. Possible variations may occur and can not be at the base of any claim.

Les informations reprises dans ce catalogue sont exactes, mais elles n'engagent aucunement notre Société du point de vue légal. Pour des exigences de production la Société se réserve le droit d'apporter toutes les dimensions sont assujettis aux variations typiques du processus de cuisson de la céramiques. Les couleurs et les effets présentés dans ce catalogue sont indicatifs dans la mesure permise par la presse, ce qui explique pourquoi ils ne peuvent pas être obligatoire et constituer la base d'un éventuel désaccord.

Die Informationen des vorliegenden Katalogs sind so exakt wie möglich, sind jedoch nicht als gesetzlich verbindlich zu betrachten. Aus Fertigungsgründen behält die Firma sich das Recht vor, eventuell notwendige Änderungen vorzunehmen. Gewicht, Farben und Abmessungen unterliegen den unvermeidlichen Veränderungen, die für den Brennvorgang von Keramikprodukten typisch sind. Die in diesem Katalog gezeigten Farben und Effekte sind Richtwerte, soweit durch die Presse, die ist, warum sie nicht bindend und stellen die Grundlage für eine Meinungsverschiedenheit gestattet.

Credit:

Marketing:
Tuscania

Progetto Grafico:
EUREKA

stampa:

finito di stampare:
SETTEMBRE 2023

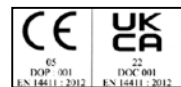

Note / Notes / Notes / Anmerkungen
I battiscopa e gli elementi "L" vengono venduti a pz. e a scatola completa.
Tutti gli altri pezzi speciali vengono venduti al pezzo.
All skirting and monolithic L elements, priced per piece, are sold in full box.
All other special trims are sold by piece.
Les plinthes et élément "L" sont vendues la pièce et par boîte complète.
Les autres pièces spéciales sont vendus la pièce.
Die Sockelleisten und Stufen werden pro Stk. und Vollen Kartons verkauft.

COSTI EXTRA/ EXTRA COST

SPESE DI IMBALLAGGIO: Sarà inoltre applicato un costo di imballo per OGNI paletta non completa.

Tale costo sarà di euro 30,00 per i formati 90x90 - 120x120 - 80x160 - 80x80 - 26x160, mentre per tutti gli altri formati il costo di imballo sarà di euro 15,00.

PER I TRASFERIMENTI PRESSO DEPOSITO ZANNI MARCO SARÀ APPLICATO

UN ADDEBITO DI € 1,20 AL Q.LE IN FATTURA.

PACKAGING FEE: A packaging fee will be applied for EACH UNCOMPLETE PALLET.

A fee of 30.00 € will be applied for the 90x90 - 120x120 - 80x160 - 80x80 - 26x160 sizes, while for all other sizes the packaging fee will be 15.00 €.

FOR LOADINGS AT ZANNI MARCO WAREHOUSE ONLY,

A FLAT FEE OF 1,20 € / 100 KGS WILL BE CHARGED DIRECTLY ON THE INVOICE.

IL PRESENTE LISTINO ANNULLA E SOSTITUISCE IL PRECEDENTE.
THIS PRICE LIST CANCELS AND REPLACES THE PREVIOUS ONE.
CE TARIF SUIVANTE ANNULLE ET REMPLACE LES PRÉCÉDENTES.
DIE VORLIEGENDE PREISLISTE ENGÄNZT UND ANNULLIERT DIE VORHERGEHENDE.

Prezzi franco fabbrica, IVA esclusa.

Ex-works prices, VAT excluded.

Prix Départ usine, TVA non compris.

Preise ab Werk, ausschl. MwSt.

LISTINO PREZZI/PRICE LIST/TARIF/PREISLISTE 2023 - €

CODICE PREZZO PRICE CODE CODE DE PRIX PREIS CODE	PREZZO / M ² PRICE / SQ.M PRIX / MQ PREIS / QM	CODICE PREZZO PRICE CODE CODE DE PRIX PREIS CODE	PREZZO / PEZZO PRICE / PCS PRIX / PCS PREIS / STCK
A01	42,87 €	P03	8,92 €
A02	46,30 €	P04	23,66 €
A10	42,87 €	P05	12,00 €
A11	44,58 €	P05A	19,20 €
A20	42,87 €	P06	19,89 €
A21	44,58 €	P07	6,17 €
A30	48,01 €	P08	3,43 €
A31	49,73 €	P10	6,17 €
A40	41,15 €	P20	33,61 €
A45	44,58 €	P21	49,38 €
A70	42,87 €	P31	106,65 €
A90	57,27 €	P32	209,19 €
A100	46,30 €	P40	132,37 €
A101	46,30 €	P41	256,52 €
A102	48,01 €	P50	17,83 €
A110	41,15 €	P51	63,10 €
C110	42,87 €	P71	15,43 €
A111	42,87 €	P72	21,26 €
A112	46,30 €	P73	17,15 €
A113	48,01 €	P74	17,83 €
A114	73,73 €	P76	17,15 €
A120	48,01 €	P77	17,15 €
A121	129,63 €	P78	21,26 €
A131	56,58 €	P79	27,43 €
A132	46,30 €	P80	17,83 €
A140	41,15 €	P82	17,15 €
A141	41,15 €	P83	28,46 €
B141	44,58 €	P84	28,81 €
A150	85,73 €	P85	31,21 €
A179	85,73 €	P90	25,38 €
A180	54,87 €	P91	10,63 €
B180	59,33 €	P92	25,38 €
B181	102,54 €	P100	102,88 €
A182	56,58 €	P101	174,90 €
B182	61,04 €	P102	267,49 €
C182	54,87 €	P102A	336,08 €
A183	90,88 €	P102B	188,61 €
B183	82,30 €	P103	137,17 €
A184	80,59 €	P104	267,49 €
A191	41,15 €	P105	360,08 €
A192	42,18 €	P105A	308,64 €
B192	44,58 €	P105B	253,77 €
A193	43,90 €	P106	192,04 €
A194	52,47 €	P106A	168,04 €
A196	46,30 €	P106B	192,04 €
A196A	54,87 €	P106C	240,05 €
A197	48,01 €	P106D	212,62 €
A198	73,73 €	P107	390,95 €
B198	75,45 €	P108	514,40 €
A199	77,16 €	P109	445,82 €
B199	77,16 €	P109A	445,82 €
C199	68,59 €	P109B	497,26 €
A200	53,16 €	P110	85,73 €
A210	61,73 €	P111	133,74 €
A210A	102,54 €	P112	164,61 €
A211	96,02 €	P112A	164,61 €
A220	48,01 €	P112B	120,03 €
B220	49,73 €	P113	377,23 €
A224	49,73 €	P113A	188,61 €
A225	80,59 €	P113B	291,50 €
B225	82,30 €	P113C	336,08 €
A226	84,02 €	P113D	226,34 €
A230	60,01 €	P114	123,46 €
B230	63,44 €	P115	264,06 €
C230	54,87 €	P116	281,21 €
A231	97,74 €	P117	394,38 €
B231	90,88 €	P118	164,61 €
A232	96,02 €		

CERSAIE / 2023

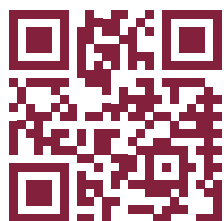

tuscaniagres.it

Tuscania S.p.A.

Via Giardini Sud, 4603
41028 Serramazzoni (Mo) - Italia
Tel. +39 0536.952399
Fax +39 0536.954716
info@tuscaniagres.it
www.tuscaniagres.it